

KINETEC[®] *Spectra*

Manuel d'utilisation

Avant toute utilisation lire ce document.
AbilityOne Kinetec se réserve le droit de toutes modifications techniques.

F

User manual

Before use, please read this document.
AbilityOne Kinetec reserves the right to effect technical modifications.

GB

Bedienungsanleitung

Vor Benutzung unbedingt dieses Dokument lesen.
AbilityOne Kinetec behält sich das Recht vor, jegliche technische Änderung durchzuführen.

D

Istruzioni per l'uso

Prima di mettere in funzione l'apparecchio leggere con attenzione il presente documento.
La AbilityOne Kinetec si riserva il diritto di apportare modifiche tecniche.

I

Manual de empleo

Antes de cualquier utilización, lea este documento.
AbilityOne Kinetec se reserva el derecho a cualquier modificación técnica.

E

Your contact:

The



KINETEC

a AbilityOne

AbilityOne Kinetec S.A.
Zone Industrielle
Rue Albert Deville, TOURNES
F-08014 Charleville-Mézières Cedex
+33 (0)3.24.52.91.21 Office
+33 (0)3.24.52.90.34 Fax

	Page
• Definition	2
• Description	3
• Safety	4
• Electrical connection	5
• Use of the hand control	
- Select your language	6
- Locking the hand control setting	7
- START/STOP/REVERSE function	7
- Quick Start	8
- Possible values for each parameter	8
- How to adjust the basic parameters of the movement	9
- How to modify programs PROGRAM MODE	10-12
- Using Programs	13
- Reading the values of a program	14

	Page
- How to use the WARM UP key	15
- How to use the MODULATION key	16
- How to use the BYPASS key	17
- Session Time	18
• Patient Pad kit	19
• Setting up the patient	20
• Options	21
• Product information	
- Maintenance	22
- Troubleshooting	22
- Cleaning	23
- Technical specifications	23
- Symbols used	24
- Warranty	24
- Maintenance sheet	25

SAFETY RECOMMENDATIONS

- The physician defines the protocol and ensures that it is correctly implemented (adjustments, session time and frequency of use).
- We recommend that you lock the hand control when you give it to the patient.
- For optimum safety, always give the hand control to the patient before starting the system.
- Explosion hazard: KINETEC Spectra is not designed for use in the presence of flammable anaesthetics.
- Check that the electrical socket is in good condition and is suitable for the splint power supply cord. The latter complies with current standards and has a grounding socket. The plug may be connected to any standard socket. The socket must however have a grounded pin.
To connect the power supply, only use the original cable supplied with the machine.
Check that the cables remain free around the device so that they do not get damaged.

Manuel N°467896275 - Updated 21/02/03

Definition

The KINETEC Spectra is a Knee PASSIVE mobilization device enabling the extension and flexion movement from -10° to 120° .

• Indications

- Knee replacement surgery.
- Fractures (patellar, tibia plateau, femoral,...).
- Arthrolysis
- Hip surgery, including hip replacement, hip pinning, osteotomy,...).
- Ligament repairs.
- Arthroscopic surgery (menisectomies, patellectomies,...)
- Burns, joints sepsis,...

• Clinical Benefits

- Breaks the cycle of trauma, inflammation and the loss of range of motion.
- Prevents joint stiffness.
- Speeds the recovery of post-operative range of motion.
- Maintains the quality of the joint surface.
- Reduces pain and edema.
- Promotes joint cartilage healing.
- Reduces hospitalization time
- Reduces the need for pain medication.
- Provides immediate post-operative continuous passive motion.
- Digital ROM readout on the patient hand control for positive reinforcement.
- Maintains desired positions for stretching and muscular rest.

• Contraindications

Bone Cancer, Warped joint surfaces, Spastic paralyse, Unstable fractures, Uncontrolled infection.
The machine are not adapted for patients height more 2 m(6'7") or under 1,40m (4'7").

KINETEC Spectra consists of the following components:

- 1 • Lower limb support.
- 2 • Thigh support.
- 3 • Foot support and hand control location for transport.
- 4 • Hand control.
- 5 • Thigh support setting lock.
- 6 • Lower limb support setting lock .
- 7 • Foot support positioning setting lock.
- 8 • Transport handle.
- 9 • ON/OFF switch and fuses.
- 10 • Liquid-crystal display (2 lines of 16 characters).
- 11 • SESSION TIME display key.
- 12 • BYPASS mode key.
- 13 • MODULATION key.
- 14 • WARM UP key.
- 15 • EXTENSION setting key.
- 16 • FLEXION setting key.
- 17 • Increase / decrease keys.
- 18 • START key.
- 19 • STOP key.
- 20 • FORCE key.
- 21 • SPEED key.
- 22 • PAUSE key.
- 23 • TIMER key.
- 24 • PROGRAM access key.

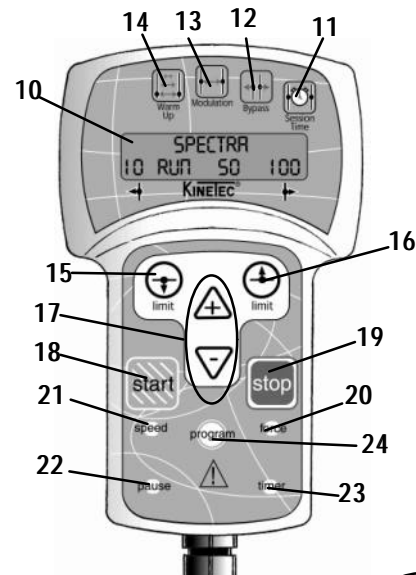
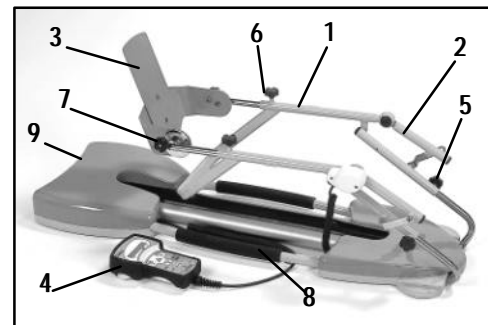

The physician defines the protocol and ensures that it is correctly implemented (adjustments, session duration and frequency of use).

The patient must know the start/stop/reverse function on the control handle. Hand control must be accessible to patient at all times. (See page 7).

KINETEC Spectra complies with Directive 93/42/CEE.

EXPLOSION HAZARD:
KINETEC Spectra is not designed for use in the presence of flammable anesthetics.

In case of electromagnetic interference with other devices move the device.

KINETEC Spectra is in compliance with standards in force (IEC 601.1.2), electromagnetic compatibility standard for medical devices.

KINETEC Spectra is a type B class I device.

Before connecting the device to the power supply, check that the mains voltage matches that shown on the identification plate (100-240 V~ 50-60Hz).

Connect the hand control (4)

Connect the power supply cable (25).

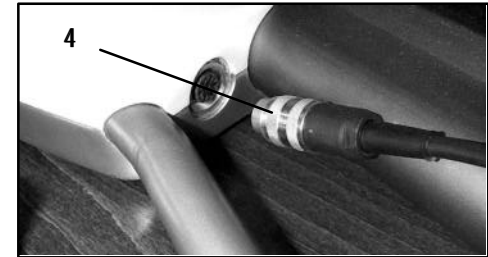
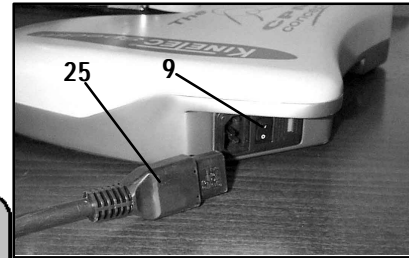

IMPORTANT

Check that the electrical socket is in good condition and is suitable for the splint power supply cord. The latter complies with current standards and has a grounding socket.

The plug may be connected to any standard socket.

The socket must however have a grounded pin.

To connect the power supply, only use the original cable supplied with the machine.

Check that the cables remain free around the device so that they do not get damaged.

Starting the unit



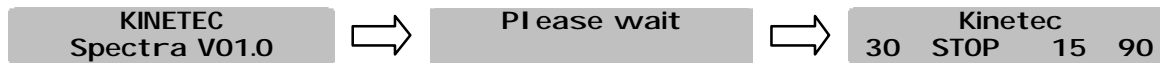

Switch on (9).

While the unit begins an auto diagnostic, the display shows the following :



Your KINETEC Spectra is ready to be used.

Select your language

Beginning	Keys to press	Display	Remarks
Switch the unit ON		<p>KINETEC Spectra V01.0</p> <p>Please wait</p> <p>Kinetec</p> <p>30 STOP 15 90</p>	Check if the hand control is not blocked (See page 7).
Press the 2 keys in the same time	 	<p>Language:</p> <p>enl ish</p>	The display indicate the language selected.
To change the language	 or 	<p>Language:</p> <p>Engl ish</p>	<p>The English language is selected.</p> <p>English French German Italian Spanish</p>
To validate the new language.	 limit	<p>Ok</p> <p>Switch on/off</p>	To exit and confirm the new language, switch OFF and Switch ON the unit.

Locking the hand control setting

The hand control allows the patient to control the machine as appropriate.



Simultaneously press the  and  keys to lock the hand control,

The display reads "LOCK", you can not change the parameters, if you try the display reads "LOCK".

To unlock the hand control, simultaneously press the  and  keys, The display reads "UNLOCK".

We recommend that you lock the hand control when you give it to the patient.

Comment: The hand control is unlocked when you switch the unit ON/OFF.

START/STOP/REVERSE function

As with all KINETEC systems, KINETEC Spectra is equipped with a START/STOP/REVERSE function.

When the unit is running, the display reads RUN

Press the  key of the hand control. The movement stops. The display reads STOP.



Press the  key of the hand control. The movement starts in the opposite direction and the display reads RUN.

Caution:

For optimum safety, always give the hand control to the patient before starting the system.

Quick Start















Set up the patient and proceed as below:

Beginning	Keys to press	Display	Remarks
Switch the unit ON		<p>KINETEC Spectra V01.0</p> <p>Please wait</p> <p>Kinetec 30 STOP 15 90</p> <p>Or</p> <p>WARMUP 30 STOP 15 90</p>	<p>Check if the hand control is not blocked (See page 7).</p> <p>If the Warm Up mode is selected, switch OFF this mode by pressing on the key </p>
Start the session with the original parameters of the movement (default setting).		<p>KINETEC</p> <p>30 run 45 90</p>	The value change at the speed of the movement.









Possible values for each parameter:

	Possible values	Default setting
• Treatment Mode		Normal
• Extension limit	-10 to 115°	30°
• Flexion limit	-5° to 120°	90°
• Speed	1 to 5 (from 30° to 160° per minute)	2
• Force	1 to 6	6
• Extension pause	0 to 900 seconds (15minutes)	0
• Flexion pause	0 to 900 seconds (15minutes)	0
• Timer	No timer(00H00) to 24H00	0













How to adjust the basic parameters of the movement

Beginning	Keys to press	Display	Remarks
To stop the unit		KINETEC 30 STOP 15 90	Check if the hand control is not blocked (See page 7).
To display the extension or flexion limit of the movement	 or 	KINETEC 30 Ext 15 90 KINETEC 40 Flex 15 90	The value blinks.
To change the limit if necessary	 Or 	KINETEC 40 Flex 15 110	The new value blinks.
To validate the new value, press another key or wait more than 3 seconds.	  	KINETEC SPEED 2 FORCE  No timer	While the value blinks press the  or  key to change if necessary.
Or Or to display pause in extension or flexion limit		KINETEC PAUSE HIGH 0 Pause low 0	Successive presses on this key selects the pause at the extension or flexion limit.
To change the pause if necessary	 Or 	KINETEC PAUSE low 15	The new pause value blinks.
To validate the new value press another key or wait more than 3 seconds. The display shows the selected mode.		KINETEC 40 STOP 15 110	The unit is ready to start with the new parameters.

How to modify programs PROGRAM MODE

Beginning	Keys to press	Display	Remarks
To switch off the unit			Check if the hand control is not blocked (See page 7).
Press the two keys at the same time and switch the unit ON	 	KINETEC Spectra V01.0	Welcome text during 3 seconds.
Then		Program 2 EMPTY	The program number blinks.
To change the program if necessary	 or 	Program 10 25 kinetec	The new program number blinks.
To choose the treatment mode		Program 10 25 warmup 110	The display indicates the selected treatment mode, the program number blinks again.
Or		Program 10 25 kinetec 110	
To display the extension or flexion limit of the movement	 or 	Program 10 30 warmup 100 Program 10 30 warmup 110	The value blinks.

How to modify programs PROGRAM MODE (continued)

Beginning	Keys to press	Display	Remarks
To change the limit of movement if necessary	 or 	Program 10 30 warmup 120	The new value blinks.
To validate the new value, press another key or wait more than 3 seconds	   	Program 10 SPEED: 2 FORCE  No timer Pause low 0	While the value blinks press the  or  key to change if necessary.
To record the program 10		Program 10 Save:+ clear:-	
Then		Program 10 Save Program 11 EMPTY	The program 10 has been recorded and the display indicates the next program so you can change another program.
OR		Program 10 clearing Program 11 EMPTY	The program 10 has been cancelled and the display indicates the next program so you can change another program.
To exit program mode, switch OFF and switch ON the unit.		KINETEC Spectra V01.0	To use the modified program see page 10.

Use of the hand control

Comments:

- When a program has been deleted, the display shows

Program 11
EMPTY

Program table:

- Program number







Program number	Treatment Mode	Flexion limit	Extension limit	Speed	Force	Flexion Pause	Extension Pause	Timer
								
1								
2								
3								
4								
5								
6								
7								
8								
9								
10								
11								
12								
13								
14								
15								
16								

 Using Programs

The KINETEC Spectra allows you to store up to 16 programs, including the type of treatment, ROM, speed, load, pauses and timer.

The original parameter values of the program are empty.







These values can be modified and recorded at any time (see 'How to enter a program' page 10).

Beginning	Keys to press	Display	Remarks
To stop the unit		KINETEC 40 STOP 15 110	Check if the hand control is not blocked (See page 7).
To access the program mode		PROGRAM 1 70 WARMUP 10	The program number blinks.
To change the program if necessary	 or 	PROGRAM 3 25 warmup 90	The new program number blinks.
To exit and validate the selected program		KINETEC Please wait	The current parameters have been recorded in program 3.
To exit without validation of selected program		KINETEC 40 STOP 15 110	Back to the starting parameters.
Start the unit		warmup 20 25 run 90	The value change at the speed of the movement.

Comments:

- The values shown in the 'Display' column are examples. They actually depend on the stored programs.
- The current movement parameters can be changed while using that program but no data will be stored in the original program. See the programming mode (p 10) to modify programs.

Reading the values of a program: example SPEED

Beginning	Keys to press	Display	Remarks
To stop the unit		KINETEC 40 STOP 15 110	Check if the hand control is not blocked (See page 7).
To access the program mode		Program 1 70 WARMUP 110	The program number blinks.
To change the program if necessary	 or 	PROGRAM 3 25 warmup 110	To change the program if necessary.
To read the speed value		PROGRAM 3 Speed 5	Displays the speed value.
After 15 seconds or after pressing on another key		PROGRAM 3 70 WARMUP 110	
To exit and validate the selected program		KINETEC 40 STOP 15 110	The current parameters have been recorded in program 3.
Start the unit		KINETEC 40 run 15 110	The value change at the speed of the movement.

Comments:

- The values shown in the 'Display' column are examples. They actually depend on the stored programs.
- The current movement parameters can be changed while using that program but no data will be stored in the original program. See the programming mode (p 10) to modify programs.



How to use the WARM UP key

Beginning	Keys to press	Display	Remarks
To stop the unit		KINETEC 40 STOP 15 110	Check if the hand control is not blocked (See page 7).
To select the Warm Up mode		WARM UP 30 STOP 15 90	The display shows the default settings (see page 8). To change the movement value if necessary see page 9.
Start the movement		WARM UP 15 RUN 15 110	The value change at the speed of the movement.

Warm Up rules:

The Kinetec Spectra starts at 70% of the full ROM, increasing 5% of the range every other cycle until the pre-set ROM is reached.

Comments:

The calculation mode used enables reaching the pre-set ROM in approximately seven full cycles.

Example:

For a Warm Up treatment with a pre-set ROM from 0° to 100°. The first cycle starts from 15° to 85° to 15° and increase 5% each cycle.

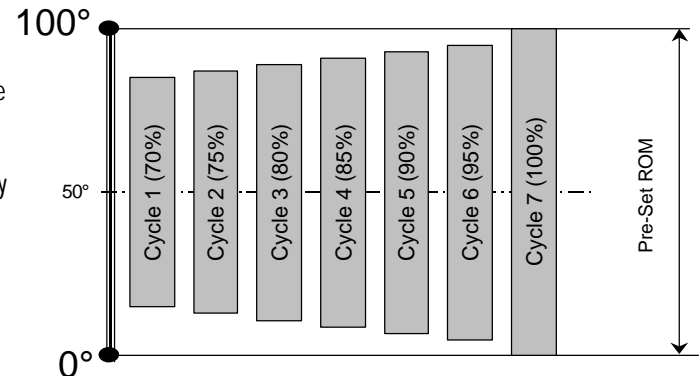

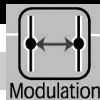











How to define the patient tolerance • At the start of a session

This function, MODULATION Mode is a way to set within the tolerance of a patient at the beginning of a session.

Set up the patient and proceed as below:







Beginning	Keys to press	Display	Remarks
Switch the unit ON		<p>KINETEC Spectra V01.0</p> <p>Please wait Kinetec 30 STOP 15 90</p> <p>Or</p> <p>WARMUP 30 STOP 15 90</p>	<p>Check if the hand control is not blocked (See page 7).</p> <p>If the Warm Up mode is selected, switch OFF this mode by pressing on the key </p>
To select the MODULATION Mode		MODUL.: use + or - 30 STOP 15 90	The display indicates the keys to be used to drive the machine, this message is displayed 3 seconds.
To select the pain level ( for flexion,  for extension)	 or 	MODUL.: use + or - 30manual 50 90	The unit is moving to the selected way. It is waiting for you to select new limits.
To set the pain level when reached, immediately press	 or 	MODUL.: use + or - 30manual 50 50	The new limit of the movement is recorded
To start the session with the new movement limits		KINETEC 30 run  45 50	The angle display changes with current movement.



How to define the patient tolerance • During the session

This function, The BY-PASS MODE is a way to address the pain threshold of a patient during a session.

IMPORTANT: Can be used only when the machine RUN.

Beginning	Keys to press	Display	Remarks
The unit is running		<p>Kinetec 30 RUN 15 90</p> <p>Or</p> <p>WARMUP 30 RUN 15 90</p>	Check if the hand control is not blocked (See page 7).
To select the BYPASS mode		<p>PYPASS: use + or - 30 RUN 15 90</p>	The display indicates the keys used to run the machine. This message is displayed 3 seconds.
To select the NEW pain level	 or 	<p>BYPASS: use + or - 30bypass 100 90</p>	The unit is moving to the selected way. It is waiting for you to select new limits.
To set the NEW pain level when reached, immediately press	 or 	<p>bypass.: use + or - 30manual 50 50</p>	The new limit of the movement is recorded.
Continue the session with the new movement limits.		<p>WARMUP 30 run 45 50</p>	The angle display changes with current movement.

Session Time



This function shows the running time (in minutes) of the session (motor functioning).

- It directly accessible by the key , the display shows

TIME	02h25
30 STOP	15 90

This counter is reset each time the unit is switched ON.

The KINETEC Patient Pad Kit is designed for rapid fitting, optimal hygiene and maximum patient comfort.

- For using and positioning the straps, please refer to here under. Make sure that the self-adhesive parts (26) are visible.
- Place the sponge side next to the skin.

**FOR OPTIMAL HYGIENE, A NEW SET OF PADS SHOULD BE USED FOR EACH PATIENT.
Each cover is provided with a label to record the patient's name**

CLEANING:

- Sterilization of the pads (if necessary): Sterilized at 134 °C during 18 minutes.
- Disinfecting of the pads: Washing at 30°C with use of a disinfecting solution during the rising cycle.

Example of product that can be used: Solution " Baclinge" at 0,125 % or "Souplanios" at 0,125% from ANIOS Laboratory.

A complete list of distributors in your country is available on request.

The KINETEC Spectra is delivered with a complete set. Components:

- 4 straps
- 1 foot support
- 1 cover

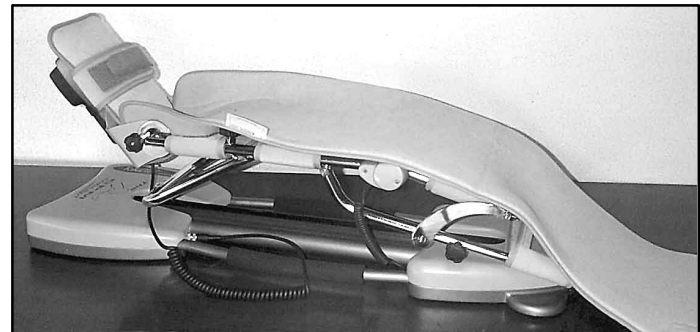
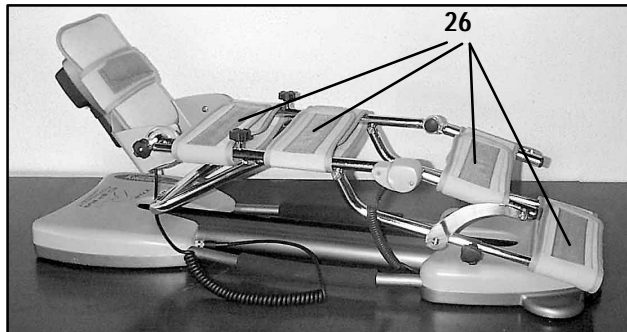

Setting up the patient

Place the KINETEC Spectra machine in a position that will be comfortable for the patient.

- Measure in cm or inches the length of the patient's femur (L); adjust the thigh support to this measurement using knobs (5)
- To install the patient on the KINETEC Spectra machine.
- Push the foot plate (3) up to the patient and tighten the knobs (6).
- Adjust the plantar flexion (40°) or the dorsal flexion (30°) of the foot, with the knobs (7).
- Adjust the internal (30°) or external (30°) flexion of the foot, with the knob (27).

IMPORTANT

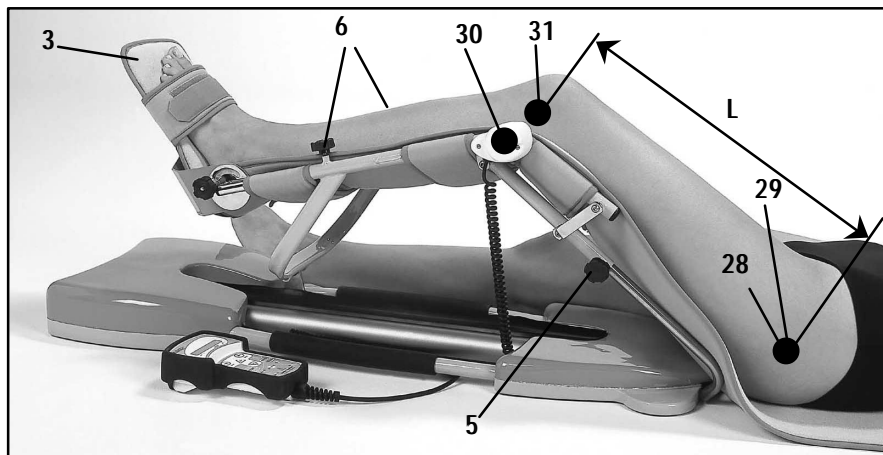
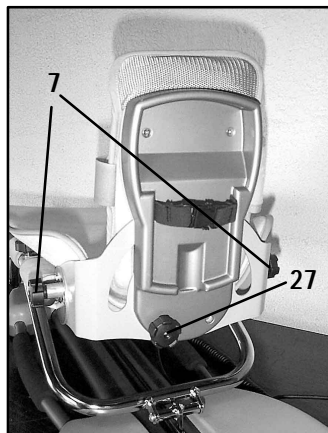

Adjust the axis of the patient's hip (28) with the axis rotation (29) of the KINETEC Spectra machine, and the axis of the patient's knee (30) with the axis rotation (31) of the KINETEC Spectra machine.





Maintenance

After 2,000 hours of operation, KINETEC Spectra requires a few lubrication and maintenance operations (lubrication of the joints, pointer stops and ball screws). The need for maintenance is indicated by display of the message SERV. MOTOR when the system is switched on. Despite that warning, you can continue to use your KINETEC Spectra by pressing START, but you should contact your nearest KINETEC technician to have the maintenance operations conducted as soon as possible.

- A motor running time counter is available. Simultaneously press keys  and , the displays shows

RESET TIME 924H
Reset: Limit Low

this counter can be resetting by pressing the key  .

Troubleshooting







A spare parts list and technical catalog are available to you on request from your KINETEC distributor. If, after connecting the power supply cable to the power supply and switching on KINETEC Spectra:







- The display does not indicate any information:
 - Check that the electrical socket is live using another device.
 - Replace the fuse(s) (32) of the connector with fuses of the same type and calibre:
2 fuses T 750 mA 250V (6.3 x 32) (KINETEC order: 4610007434).
 - If the display still does not indicate any information, contact your nearest KINETEC technician.
- Your KINETEC Spectra does not work and the display indicates 50 STOP 25 115,
Press START again.
Your KINETEC Spectra still does not function: Contact your nearest KINETEC technician.
- Your KINETEC Spectra does not function and the display indicates:
ANGULAR POSI.: angle measurement function failure,
or NO MOVEMENT: no movement,
or BAD WAY: motor rotation failure,
or LOAD MAXI: abnormal consumption,
or POWER SUPPLY: power failure;
Contact your nearest KINETEC technician if the same message is displayed after having switched the device off, then on, and started it by pressing START.









Product information

Symbols used

	TYPE B device (protection against electric shocks)
	Caution (consult the accompanying documents)
	STOP (power off)
	ON (power on)
	Start movement
	Stop movement
	Program access

	Speed
	Timer
	Force
	Pause
	Increase
	Decrease
	Extension limit

	Flexion limit
	Warm Up
	Modulation
	Bypass
	Session time
	Alternative current

Warranty

The KINETEC warranty is strictly limited to the replacement free of charge or repair in the plant of the component or components found to be defective. KINETEC guarantees its joint passive mobilization systems for 1 year against all defects of manufacture from the date of purchase by the consumer. KINETEC is the only organization able to assess the application of the warranty to its systems.

The warranty will be considered null and void if the device has been used abnormally or under conditions of use other than those indicated in the user's manual. The warranty will also be considered null and void in the event of deterioration or an accident due to negligence, inappropriate surveillance or inappropriate maintenance, or due to transformation of the equipment or an attempt to repair the equipment.

Serial number: _____
Purchasing date: _____

Date: _____	Operations done: _____
Technician: _____	_____
Running time (see page 22): _____	_____
Exchange parts: _____	_____
_____	_____

Date: _____	Operations done: _____
Technician: _____	_____
Running hours (see page 22): _____	_____
Exchange parts: _____	_____
_____	_____

GROUPEMENT POUR L'ÉVALUATION DES DISPOSITIFS MÉDICAUX



ATTESTATION/ CERTIFICATE N° 0912 / B2P3 / 1
Renouvellement de l'attestation N°0214/B2P3/1 du 12/11/1997

Délivrée à Fontenay aux Roses le 16 octobre 2002
Issued in Fontenay aux Roses on October 16th, 2002

LCIE Membre du GIE G-MED

ATTESTATION CE / EC CERTIFICATE

Approbation du Système Qualité Complet d'Assurance Qualité / Approval of full Quality Assurance System
ANNEXE II point 3 Directive 93/42/CEE relative aux dispositifs médicaux
ANNEX II section 3 DIRECTIVE 93/42/EEC concerning medical devices

Fabricant (nom et adresse)
Manufacturer (name and address)

ABILITYONE KINETEC S.A.
Zone Industrielle
Rue Albert Deville
TOURNES
08014 CHARLEVILLE MEZIERES CEDEX
FRANCE

Catégorie du(des) dispositif(s)

Dispositifs d'immobilisation, de mobilisation et
d'évaluation des articulations du corps humain
de marque KINETEC
Immobilization, mobilization and testing devices
of the human joints sold under the KINETEC name

Device(s) category

Le G-MED atteste qu'à l'examen des résultats figurant dans le rapport référencé 60000010, le système d'assurance qualité - pour la conception, la production et le contrôle final - des dispositifs médicaux énumérés ci-dessus est conforme aux exigences de l'annexe II point 3 de la Directive 93/42/CEE.
G-MED certifies that, on the basis of the results contained in the file referenced 60000010, the quality system - for design, manufacturing, and final inspection - of medical devices listed here above complies with the requirements of the Directive 93/42/EEC, annex II section 3.

Cette attestation est valable jusqu'au : 16 octobre 2005 (inclus)
This certificate is valid until : October 16th, 2005 (included)

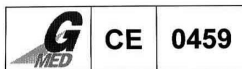

Pour l'Administrateur
For the Administrator

Isabelle HELLER

B2P3

1999-03-15

33, AVENUE DU GÉNÉRAL LECLERC - BP 8 - F 92260 FONTENAY AUX ROSES - TEL. : 01 40 95 63 54 - FAX : 01 40 95 62 43
TEL. INTER. : +33 1 40 95 63 54 - FAX INTER. : +33 1 40 95 62 43 - e-mail : gmed@lcie.fr - TVA Intracomm. : FR 64395030505
Groupement d'intérêt économique régi par l'ordonnance du 23 septembre 1967 modifiée - SIREN 395 030 505 RCS Nanterre

GROUPEMENT POUR L'ÉVALUATION DES DISPOSITIFS MÉDICAUX



CERTIFICAT CERTIFICATE OF REGISTRATION

N° 0912 / 9001 - 46001 / 1

Renouvellement du certificat N°0214/9001-46001/1 du 15/10/1997

LCIE Membre du GIE G-MED

Le G-MED certifie que le système qualité développé par
G-MED certifies that the quality assurance system developed by

ABILITYONE KINETEC S.A.
Zone Industrielle
Rue Albert Deville
TOURNES
08014 CHARLEVILLE MEZIERES CEDEX
FRANCE

pour les activités
for the activities

Conception, fabrication, vente et service après-vente de dispositifs d'immobilisation,
de mobilisation et d'évaluation des articulations du corps humain de marque KINETEC
Design, manufacturing, sales and servicing of immobilization,
mobilization and testing devices of the human joints sold under the KINETEC name

réalisées sur le(s) site(s) de
performed on the location of

même adresse (same address)

est conforme aux exigences des normes internationales
complies with the requirements of the international standards

ISO 9001 (2000) - EN 46001 (1996)

Date de délivrance : 16 octobre 2002
Date of issue October 16th, 2002

Date d'expiration de validité : 16 octobre 2005 (inclus)
Limit expiry date October 16th, 2005 (included)



Pour l'Administrateur
For the Administrator

Isabelle HELLER

Ce certificat est délivré selon les règles G-MED de certification. / This certificate is issued according to the G-MED's rules of certification.
G-MED Organisme notifié pour les Dispositifs Médicaux G-MED Notified Body for Medical Devices

3Q

1999-03-15

33, AVENUE DU GÉNÉRAL LECLERC - BP 8 - F 92260 FONTENAY AUX ROSES - TEL. : 01 40 95 63 54 - FAX : 01 40 95 62 43
TEL. INTER. : +33 1 40 95 63 54 - FAX INTER. : +33 1 40 95 62 43 - e-mail : gmed@lcie.fr - TVA Intracomm. : FR 64395030505
Groupement d'intérêt économique régi par l'ordonnance du 23 septembre 1967 modifiée - SIREN 395 030 505 RCS Nanterre