

OptiFlex[®]

SERVICE MANUAL

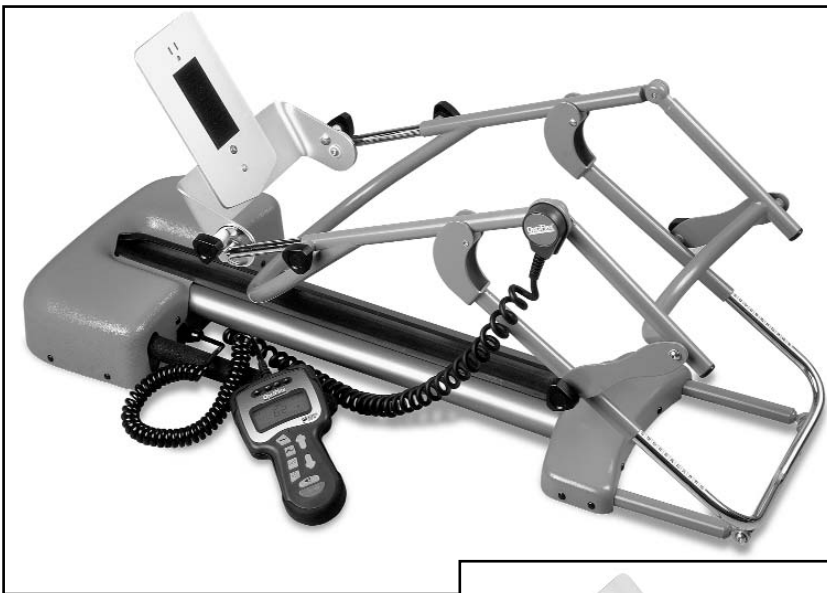

Models:

2030

(Serial Numbers- 5000 and above)

2060

(Serial Numbers- 5000 and above)

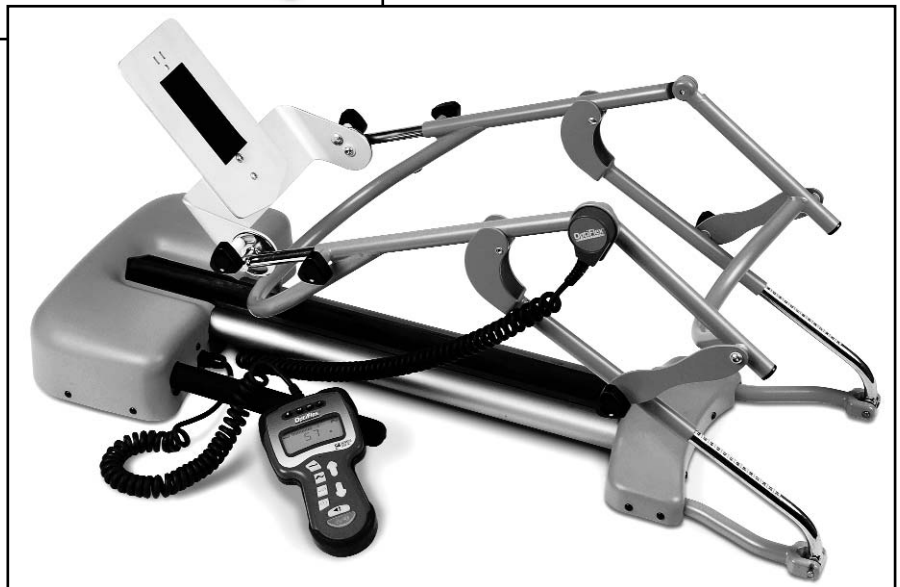

TABLE of CONTENTS

OptiFlex® 2030 & 2060

Forword	1
1- Safety Precautions	2-3
1.1 Precautionary Symbol Definitions	2
1.2 Safety Precautions	3
2- Theory of Operation	4
3- Nomenclature	5-6
4- Specifications	7
5- Troubleshooting	8-11
6- Removal & Replacement Procedures	12-17
8-Calibration	18-19
9- Replacement Parts	20-23

Read, understand and follow the Safety Precautions and information contained in this manual.

This manual contains the necessary safety, and field service information for those Field Service Technicians, approved by Chattanooga Group, to perform field service on the OptiFlex CPM Models 2030 and 2060 units.

At the time of publication, the information contained herein was current and up to date. However, due to continual technological improvements and increased clinical knowledge in the field of electrotherapy, as well as Chattanooga Group's policy of continual improvement, Chattanooga Group reserves the right to make periodic changes and improvements to their equipment and documentation without any obligation on the part of Chattanooga Group.

It is the sole responsibility for field technicians to stay informed and trained in the latest technology utilized in the OptiFlex CPM Models 2030 and 2060 units by Chattanooga Group from time to time, as significant improvements are incorporated, Service Bulletins will be produced and made available on our web site (www.chattgroup.com) in lieu of reprinting a complete manual prematurely. These Service Bulletins will provide updated service information and technology improvements to the OptiFlex CPM Models 2030 and 2060 for use by approved service technicians.

“Approved Service Technician” Definitions;

- 1. Level I-** Those Field Service Technicians that have successfully completed the minimal training required by Chattanooga Group, in basic service techniques.
- 2. Level II-** Those Field Service Technicians that have successfully completed Level I Training as well as Level II training as required to perform specific troubleshooting and repair techniques and procedures.
- 3. Level III-** Those Field Service Technicians that have successfully completed Levels I & II Training as well as Level III Advanced Training as required to perform all necessary Troubleshooting and Repair techniques. The Technician having successfully completed the three levels of training and coupled with experience should have the ability to train other technicians in Level I and Level II Training with the necessary Training Materials from Chattanooga Group.
- 4. Temporary-** Chattanooga Group, at its discretion and based on known experience of the technician, may grant a “Temporary Approval” to a field technician for particular troubleshooting and repair of a specific unit requiring immediate attention. This “Temporary Approval” in no fashion acknowledges the training level of a technician as defined above. This “Temporary Approval” is utilized only in unique situations for a specific unit for a specific service technique only and is documented as such.

Due to the complex nature of the technology utilized by Chattanooga Group, the recommended troubleshooting techniques are to determine “Bad Board” and board replacement only. No board component level troubleshooting is recommended nor will information or parts be supplied by Chattanooga Group. Any board component level troubleshooting performed will be at sole risk and liability of the Service Technician performing such troubleshooting techniques.

This equipment is to be sold and used only under the prescription and supervision of a licensed medical practitioner.

This equipment is to be serviced only by an “Approved Service Technician”.

For Additional Service Contact:
Chattanooga Group
CPM Support Department
Toll Free: 1-866-266-0026
Outside USA: +1-423-870-7200

Precautionary Symbol Definitions

The precautionary instructions found throughout this manual are indicated by specific symbols.

Understand these symbols and their definitions before operating or servicing this equipment. The definitions of these symbols are as follows:



A. CAUTION

Text with a “CAUTION” indicator will explain possible Safety infractions that could have the potential to cause minor to moderate injury or damage to equipment.



B. WARNING

Text with a “WARNING” indicator will explain possible Safety infractions that will potentially cause serious injury and equipment damage.



C. DANGER

Text with a “DANGER” indicator will explain possible Safety infractions that are imminently hazardous situations that would result in death or serious injury.



D. EXPLOSION HAZARD

Do not use this equipment in the presence of flammable anesthetics. This symbol is also prominently displayed on the serial number plate of the unit.

E. NOTE:

Throughout this manual “NOTE” may be found. The Notes are helpful information to aid in the particular area or function being described.

Safety Precautions

Read, understand and follow all safety precautions found in this manual. Below are general safety precautions that must be read and understood before attempting any service techniques on these units.

Throughout this manual specific safety precautions will be found. Read, understand and follow all safety precautions.



- Read this manual before assembling or using OptiFlex.
- Only use OptiFlex on solid, flat surfaces.
- Extreme caution should be taken when in use around children.
- Use OptiFlex only as described in this manual.
- Keep hair, loose clothing, fingers and all parts of body away from moving parts of OptiFlex.
- DO NOT use OptiFlex outdoors or on wet surfaces.
- Materials may become flammable or combustible if exposed to a source of ignition.
- Disconnect electrical supply before servicing or cleaning. Failure to do so could result in electrical shock or personal injury.
- DO NOT use OptiFlex while smoking or around open flame.
- Exercise caution when using accessories and auxiliary devices such as muscle stimulators, ColPaCs and other modalities.
- Turn power off before unplugging.
- Unplug the power supply by grasping the plug not the cord.
- Damage may occur to OptiFlex if not transported and stored between 0° and 140°F (-18° to 60°C).
- Unplug power supply when not in use.
- DO NOT use if cord or plug is damaged.
- Use extra care when touching metal of OptiFlex after exposure to cold or heat.
- DO NOT handle any electrical apparatus with wet hands.
- Condensation could result and damage OptiFlex if unit is subjected to periods of low temperatures followed by periods of high temperatures.
- DO NOT use on unstable surfaces or liquid filled devices such as water mattresses or flotation pads.

Safety Precautions Continued

CAUTION

- OptiFlex has been designed for maximum protection against the exposure of urinary incontinence. Precautionary measures should still be taken, when any type of liquid comes in contact with an electrical apparatus.
- OptiFlex is made from high impact materials. However, structural failure or hidden damage can be caused by shock, impact or dropping the unit. Use care when transporting and storing unit to avoid equipment damage.
- To isolate the unit from the power source, disconnect the power cord at the wall outlet.
- OptiFlex should only be used after the operator has thoroughly read and understands the User Manual.
- Rapid increases in ROM can cause complications.
- OptiFlex is not to be used in the presence of flammable anesthetic mixture with air or with oxygen or nitrous oxide.

WARNING

- Make certain that the unit is electrically grounded by connecting only to a grounded electrical service receptacle conforming to the applicable national and local electrical codes.
- Keep hair, loose clothing, loose bedding, fingers and toes away from the hinge components of the unit.
- Do not use the OptiFlex outdoors, on wet or gel filled surfaces. Use only on firm, flat, stable level surfaces to ensure stability of the unit while in operation.
- Materials of the unit may become flammable or combustible if exposed to a source of ignition.
- Heat generated within the pendant may cause ignition of the pendant if wrapped in bedding or other materials.
- DO NOT use OptiFlex while smoking or around open flame.
- OptiFlex has been designed for maximum protection against the exposure of urinary incontinence. Precautionary measures should still be taken when any type of liquid comes in contact with an electrical apparatus.
- Always turn off and unplug unit from electrical source before servicing or cleaning. Failure to do so could result in electrical shock or personal injury.
- Handle the unit only when unit is dry and hands are dry to prevent electrical shock.
- Do not use the OptiFlex as a toy.

DANGER



- Explosion hazard if used in the presence of flammable anesthetics. The warning symbol for this hazard is prominently displayed on the serial number plate.
- Exercise caution when using accessories and auxiliary devices such as muscle stimulators, ColPaCs and other modalities. Route lead wires, hoses, tubes, etc away from the working mechanism of the OptiFlex to help prevent damage to the Optiflex and any other modality used with it.
- Unconscious patients or patients under heavy influence of medication must be constantly attended and monitored while the OptiFlex is in use.
- The OptiFlex unit must be completely visible at all times during use. Never cover the unit with bedding or any other means of concealment while in operation.
- If the OptiFlex is used in conjunction with the optional OptiFlex "T" trolley, make certain the OptiFlex unit is resting on the mattress of the bed and the OptiFlex "T" is suspended with no weight on the casters to prevent possible movement of the unit and or possible injury to patient.
- OptiFlex is a prescription device used under the supervision of or by the order of a physician or other licensed healthcare provider.

2.1 Overview

The OptiFlex 2030 & 2060 CPM products are comprised of two PC Board assemblies housed within the head section of the unit along with the Motor and Gearbox Assembly. These components are linked to a Pendant via a cable connection that provides the operator access for set up and operation of the unit. The basic components of the OptiFlex CPM units are Frame Base, Motor and Gearbox Assembly, Power Transformer, Motor Control Board, Power Supply Circuit, Adjustable Femur Bar, Adjustable Foot Plate and User Interface (Pendant). The units are designed for patient use only with the Patient Softgoods Kit (Part Number 20533). This single patient use softgoods kit is designed specifically for the OptiFlex 2030 & 2060 CPM units and provides proper installation and support to the patient during therapy. See Figure 2.1. If necessary, two units may be used simultaneously for patients that have been prescribed dual therapy by a licensed professional. If two units are prescribed for use simultaneously, use with the optional bed mount to secure the units in position during therapy.

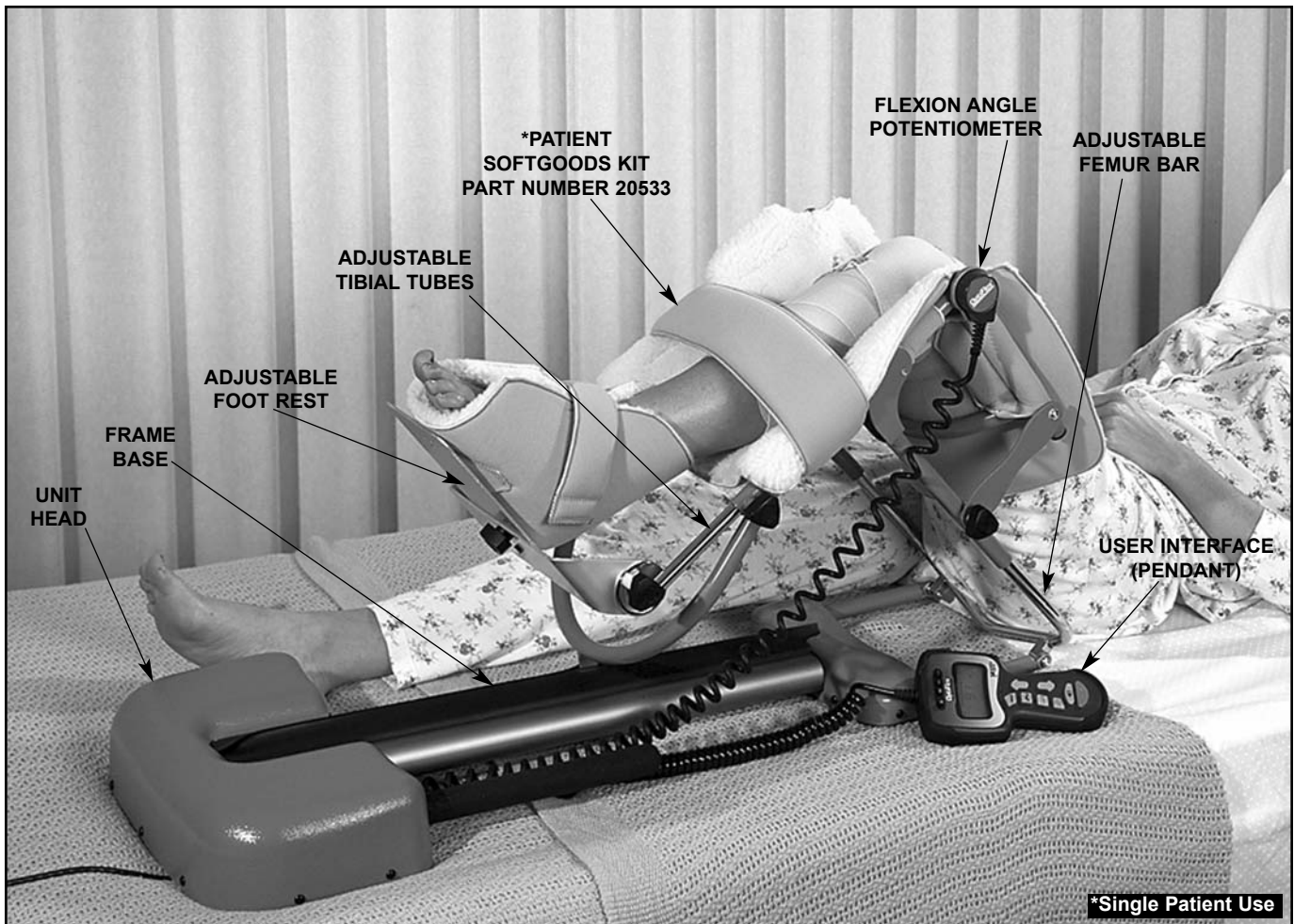

FIGURE 2.1

3.1 OptiFlex Familiarization

The nomenclature graphics below, Figure 3.1, indicate the general locations of the major components of the OptiFlex CPM unit.

Know the components and their functions before performing any operation of or service to the OptiFlex 2030 or 2060 CPM unit.

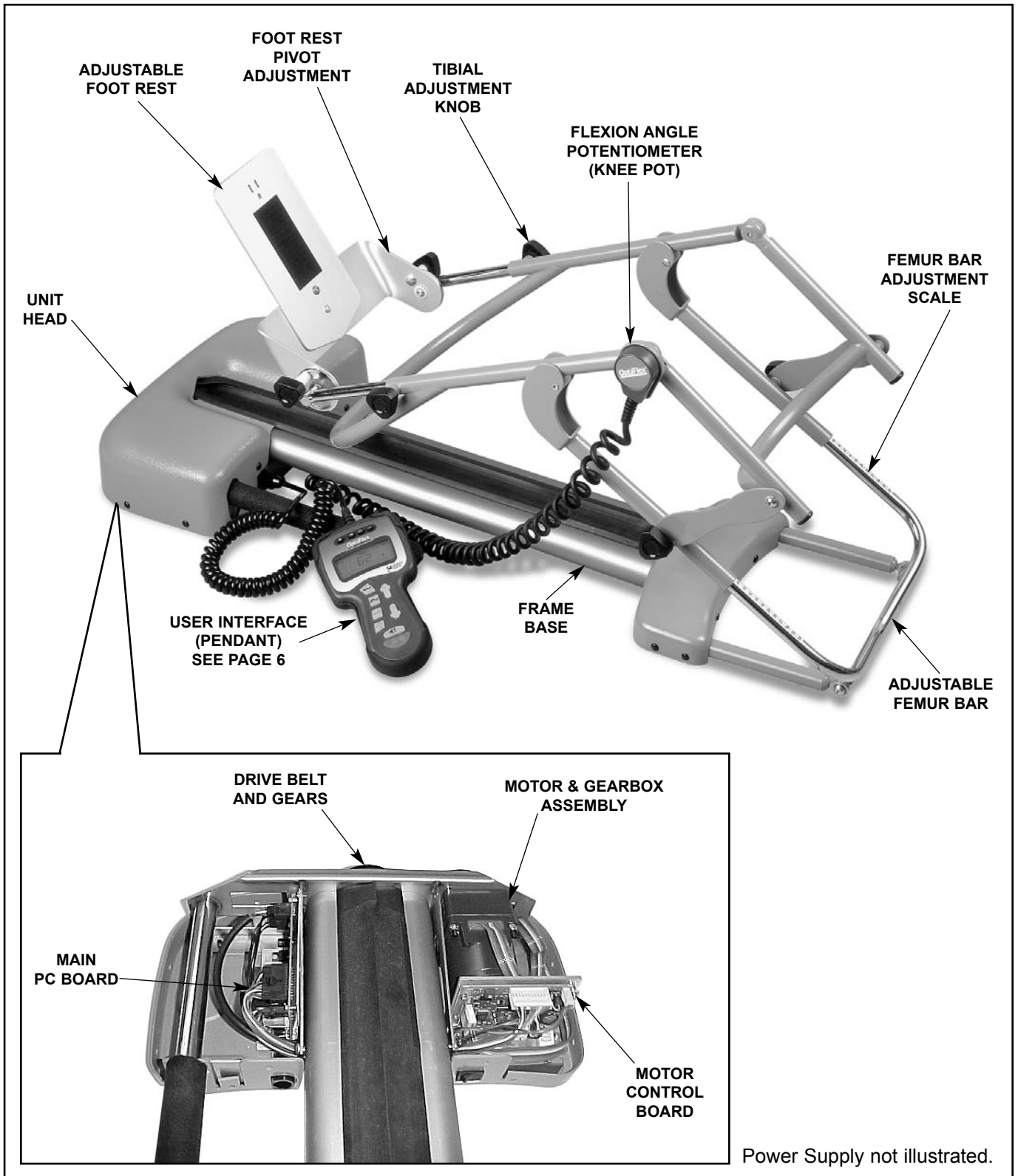

FIGURE 3.1

3.2 OptiFlex Pendant Familiarization

The Pendant nomenclature graphics below, Figure 3.2, indicate the location and functions of the OptiFlex CPM Pendant (user interface).

Know the components and their functions before performing any operation of or service to the OptiFlex 2030 or 2060 CPM unit.

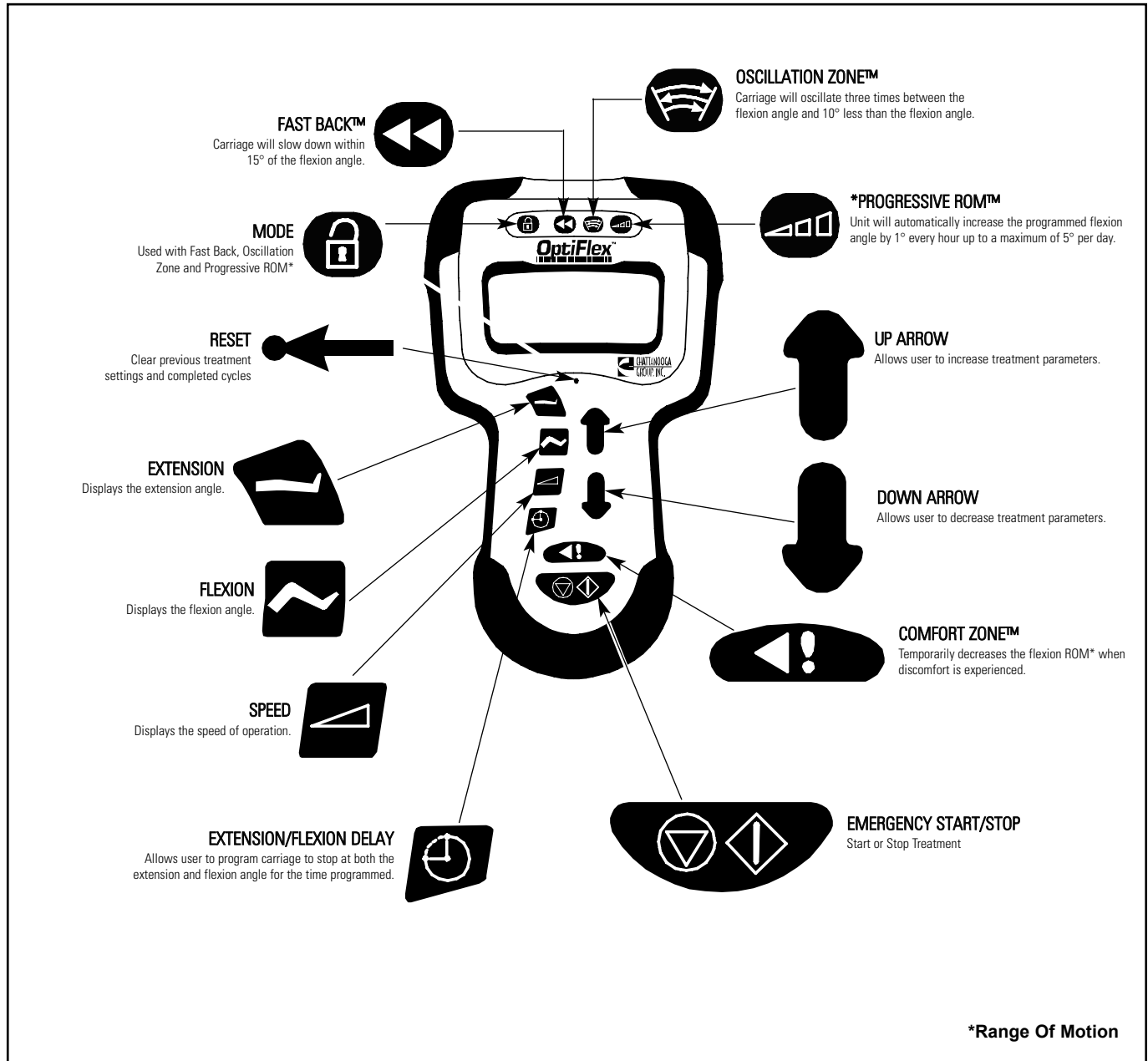

FIGURE 3.2

SPECIFICATIONS

OptiFlex® 2030 & 2060

MODEL 2030

Input: 120 VAC-50/60 Hz, 40 Watts

Weight: 28 Lbs. (13 kg)

Length: 37 in. (94 cm)

Operation

Knee Flexion ROM Limit: 120°

Knee Extension Limit: -10° Hyper Extension

Knee Speed Range : 30°/min. to 150°/min. Nominal

Maximum Patient Weight: 350 Lbs. (159kg.)

Calf Length Range: 10 to 23.5 in. (25.4 to 59.7 cm)
(knee joint to sole of foot)

Thigh Length Range: 12 to 19 in. (30.5 to 48.3 cm)
(hip joint to knee joint)

Transportation and Storage

Unit should be transported and stored within the following conditions:

Temperature: 0° - 140°F (32° - 60°C)

Humidity: 0 - 75% Relative Humidity

MODEL 2060 (International)

Input: 230 VAC-50/60 Hz, 40 Watts

Weight: 28 Lbs. (13 kg)

Length: 37 in. (94 cm)

Operation

Knee Flexion ROM Limit: 120°

Knee Extension Limit: 10° Hyper Extension

Knee Speed Range : 30°/min. to 150°/min. Nominal

Maximum Patient Weight: 350 Lbs. (159kg.)

Calf Length Range: 10 to 23.5 in. (25.4 to 59.7 cm)
(knee joint to sole of foot)

Thigh Length Range: 12 to 19 in. (30.5 to 48.3 cm)
(hip joint to knee joint)

Transportation and Storage

Unit should be transported and stored within the following conditions:

Temperature: 0° - 140°F (32° - 60°C)

Humidity: 0 - 75% Relative Humidity

5.1 OptiFlex Software Error Messages

A. The information provided below is intended to aid in troubleshooting Software Error Messages of the OptiFlex Units to “Board Level” only. No component level troubleshooting information is

or will be provided by Chattanooga Group for field troubleshooting of board components.

B. Once a particular PCB has been determined as bad, replace the suspected board.

ERROR MESSAGE	PROBABLE CAUSE	POSSIBLE REMEDY
RAM Test Failed	Pendant	Replace Pendant
Checksum Test Failed	Pendant	Replace Pendant
(2) Motor Failure	1. Carriage Angle <-15° 2. Carriage Angle >125°	Replace Pendant Adjust or replace knee pot.
(3) Motor Failure	Motor Speed Counter	Make certain Femur Adjustment knobs are tight.
Carriage Obstruction, Treatment Stopped	1. Motor Overcurrent 2. Carriage Stuck or in Bind	Calibrate unit. Should calibration not clear the problem, send unit to factory for service.
Pendant is not Connected	1. Loop Around 2. DAC Speed Out	Connect Pedant to unit. If this does not correct the problem, replace pendant
(2) Failure	RTC 3V Battery (A/D Pendant)	Replace pendant battery. If this does not correct problem, replace pendant.
(3) Failure	Monitor 8V (A/D Pendant)	Cable
(4) Failure	Monitor 24V (A/D SPI)	Cable, knee pot, main PCB
(5) Failure	Monitor 5V (A/D SPI)	Cable
Stuck Button	Sticky Deposits	Remove and clean button pads, inspect switch lands. If this does not correct problem, replace pendant.

5.2 OptiFlex System Testing

A. General

1. The following information is intended to aid in troubleshooting the major components of the OptiFlex Units to "Board Level" only. These tests are OEM standard testing procedures and methods used at the factory before shipment of any OptiFlex unit.
2. Due to the complex nature of the technology utilized by Chattanooga Group, the recommended troubleshooting techniques are to determine "Bad Board" and board replacement only. No board component level troubleshooting is recommended nor will information or parts be supplied by Chattanooga Group. Any board component level troubleshooting performed will be at sole risk and liability of the Service Technician performing such troubleshooting techniques.
3. Once a particular PC Board has been determined as bad, replace the board only with Chattanooga Group OEM replacement parts and hardware.

B. Special Tools, Fixtures & Materials Required

1. Certain tests require the use of special Tools and/or Fixtures. These will be listed at the particular test where they are required. Testing with any other special tool or fixture other than those stated could give erroneous readings or test results. Always perform the tests exactly as stated to ensure accurate results.
2. Standard test equipment settings will be listed for each test performed to aid in performing the test to OEM standards and ensure proper readings.
3. The troubleshooting and repair of the OptiFlex units, should be performed only by authorized technicians trained and certified by Chattanooga Group.

C. Equipment Required

1. Digital Multimeter
2. Dielectric Withstand (Hi-Pot) and ground resistance tester.
3. Milliohm Meter.

NOTE:

Adjust Dielectric Withstand tester to indicate fault with 120k Ohm Load across the output when at specified test voltage.



CAUTION

The following tool, lubrication and locking compound requirements are critical to the component removal and replacement of the OptiFlex.

All hardware, bolts, nuts and screws, used to assemble the OptiFlex are SAE Standard. Due to the size of these components no metric equivalent is available. Therefore, it will be necessary to obtain the proper size tools for removal and replacement of certain components.

The lubricants and locking compounds listed below are crucial in the assembly of certain components to ensure patient safety and efficient operation of the unit. Use only the recommended products listed or an approved equivalent possessing the same properties and qualities.

5. Required SAE Tools

- #1 Phillips Screwdriver
- #2 Phillips Screwdriver
- Preset and calibrated, 5 inch pound "T"-Handle Torque Wrench with 1/4" square drive and 5/64" straight hex key socket.
- Preset and calibrated, 10 inch pound "T"-Handle Torque Wrench with 1/4" square drive and 9/64" straight hex key socket.
- 5/16" Socket Driver
- 3/32" Allen Wrench

6. Required Lubricants

- Molykote 33 Grease (Light Pink) by Dow Corning.
- MolyGraph Grease (Black) by Sta-Lube.

7. Required Locking Compound and Primer

- Type N Primer by Loctite
- Loctite 222 (Purple)
- Loctite 242 (Blue)
- Loctite 262 (Red)
- Loctite 609 (Green)

8. Inclinator, Protractor or Goniometer accurate to 1°.
9. Certified, calibrated Stop Watch.

NOTE:

The tool, lubricant and locking compound requirements will be listed at the respective removal and replacement procedures throughout this manual.

5.3 Visual Inspection

A. General

Visually inspect the OptiFlex unit. A visual inspection can, to an experienced Technician, indicate possible abuse of the unit and/or internal problems.

5.4 Ground Resistance Test

A. Voltage Specifications

Model 2030 Input: 120 VAC~50/60 Hz, 40 Watts

Model 2060 Input: 230 VAC~50/60 Hz, 40 Watts

B. Specification

Maximum Acceptable Resistance: 500 milliohms

C. Equipment Required

Milliohm Meter

D. Test

Place unit on level work surface.

Place one meter probe on the ground prong of power supply and the other to any exposed metal or screw on the unit. See Figure 5.1.

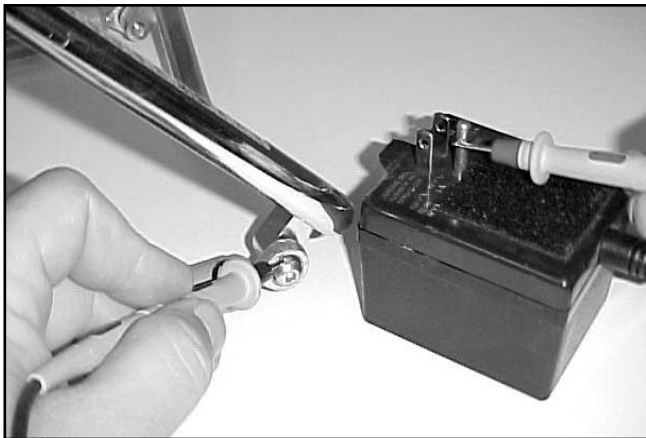

FIGURE 5.1

5.5 Leakage Tests

Test Voltage Spec 1000V

Conduct all necessary leakage tests as required per "Chapter 7 Electrical Equipment" of the 1999, or later, edition of the NFPA (National Fire Protection Association) "Health Care Facilities" standards. See Figure 5.2.

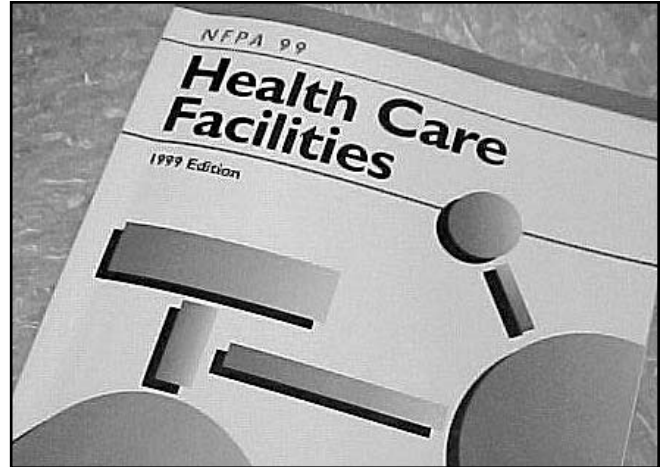

FIGURE 5.2

5.6 Flexion Angle & Calibration Test

Spec $90^{\circ} \pm 2^{\circ}$

A. Equipment Required

Inclinometer, Protractor or Goniometer accurate to 1°

B. Test

Place unit on level work surface.

Plug unit transformer into grounded wall outlet with appropriate voltage. See Specifications on page 7.

Connect Pendant to Unit and turn unit power ON.

Press and hold the Extension button. While holding the Extension button down, press the Down arrow until -10 is displayed on the Pendant. See Figure 5.3.

Press and hold the Flexion button. While holding the Flexion button down, press the Up arrow until 120 is displayed on the Pendant. See Figure 5.4.



FIGURE 5.3



FIGURE 5.4



FIGURE 5.5

Press and hold the Speed button. While holding the Speed button down press the Up or Down arrow button until 90 is displayed on the Pendant. See Figure 5.5.

Press the Emergency Start/Stop button on the Pendant. When the number on the Pendant display reads 90, press the Emergency Start/Stop button to stop movement of the unit.

! WARNING

UNIT FAILING DIELECTRIC WITHSTAND AND/OR LEAKAGE TESTS COULD INDICATE SERIOUS INTERNAL SYSTEM PROBLEMS.
DO NOT PLACE UNIT BACK INTO SERVICE! SEND UNIT TO FACTORY FOR REPAIR! DO NOT ATTEMPT TO REPAIR IN THE FIELD!

Using the Inclinometer or Protractor measure the angle of the flexion of the unit. Compare to Spec. See Figure 5.6.



FIGURE 5.6

NOTE:

In Figure 5.6, a Digital Inclinometer is used to measure each side and the two numbers are added together.

5.7 Travel Speed Test

Spec. 0° to 90° in 65 Seconds ±8%

A. Equipment Required

Calibrated Stop Watch

B. Test

Set unit up as described in the “Flexion Angle Test”
Press the Emergency Start/Stop button and start the Stop Watch when the Pendant reads 0. The unit should move from 0° to 90° within the specification listed above.

Repeat and record results three times. Record the average.

5.8 Emergency Start/Stop Function Test

Spec. Unit Start or Stop upon pushing button

A. Equipment Required

OptiFlex® with Pendant

B. Test

Place unit on a level work surface.
Plug unit power supply into grounded wall outlet with appropriate voltage. See Specifications on page 7.
Connect Pendant to Unit and turn unit power ON.
Press the Emergency Start/Stop button to start and stop the unit. Repeat several times.

5.9 Pendant Disconnect Test

Spec.Unit Stops immediately upon Pendant disconnect

A. Equipment Required

OptiFlex with Pendant

B. Test

Place unit on a level work surface.
Plug unit power supply into grounded wall outlet with appropriate voltage. See Specifications on page 7.
Connect Pendant to Unit and turn unit power ON.
Press the Emergency Start/Stop button to start the unit.
Disconnect the Pendant from the unit while moving. Unit should stop.

6.1 Cover Removal & Replacement

WARNING

UNPLUG THE UNIT FROM THE POWER SOURCE BEFORE ATTEMPTING ANY REMOVAL OR REPLACEMENT PROCEDURES TO PREVENT ELECTRICAL SHOCK.

A. Motor Cover Removal

Remove the 11 Male Push Rivets from the Blue Motor Cover by hand. See Figure 6.1

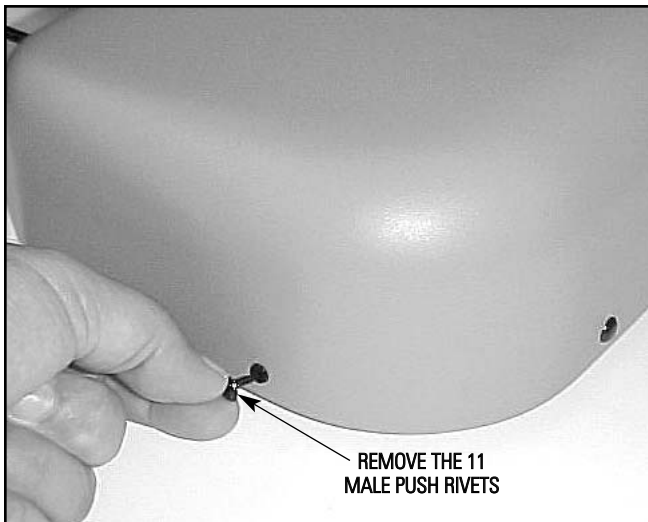

FIGURE 6.1

Remove the 11 Female Push Rivets from the Blue Motor Cover by hand. See Figure 6.2.

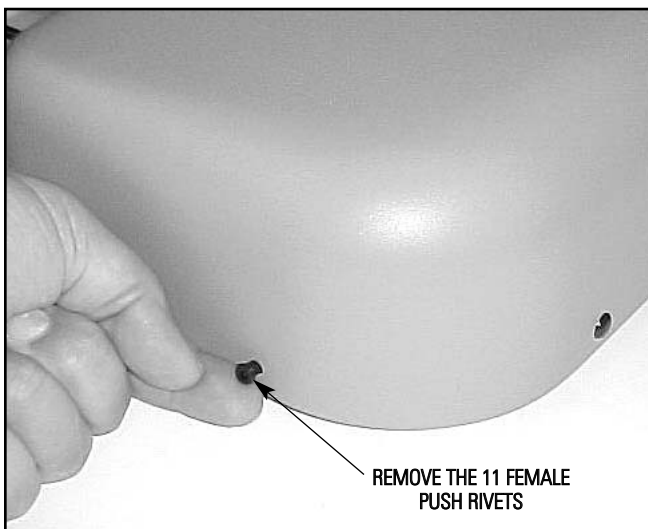

FIGURE 6.2

Lift up and rotate the Blue Motor Cover toward the carrying handle of the unit. Then slide the cover over the carrying handle to completely remove from the unit.

NOTE:

Retain both parts of the push rivets for re-installation.

B. Rear Access Cover

Remove the 6 Male Push Rivets from the Blue Rear Access Cover by hand. See Figure 6.3.

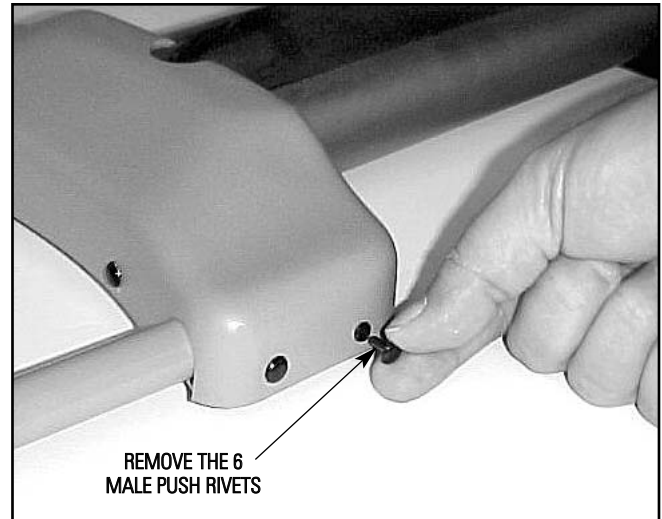

FIGURE 6.3

Remove the 6 Female Push Rivets from the Blue Front Access Cover by hand. See Figure 6.4.

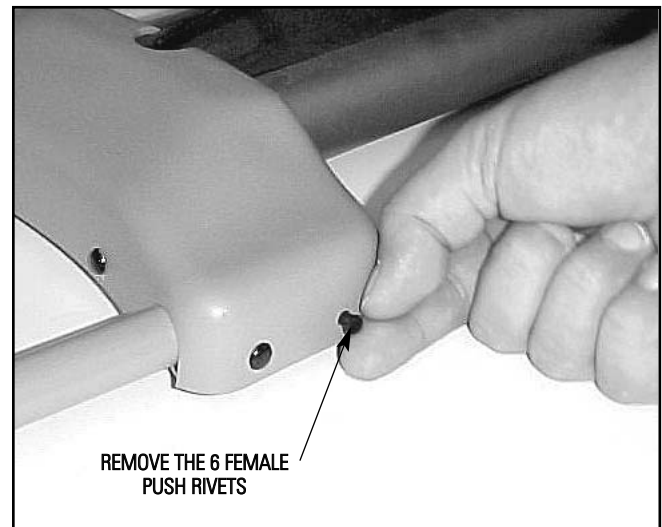

FIGURE 6.4

C. Replacement Component Part Numbers

Push Rivet (Male & Female Components)	J6004
Motor Cover	J2007
Front Access Cover	J2005

D. Replacement

Replace both covers in reverse order of removal.

6.2 Main PC Board Removal & Replacement

A. Tools Required

#2 Phillips Screwdriver

WARNING

UNPLUG THE UNIT FROM THE POWER SOURCE BEFORE ATTEMPTING ANY REMOVAL OR REPLACEMENT PROCEDURES TO PREVENT ELECTRICAL SHOCK.

B. Motor Cover Removal

Remove Motor Cover. Refer to "6.1. Cover Removal & Replacement".

C. Main PC Board Removal

Disconnect the six wiring harnesses from the main board. See Figure 6.5.

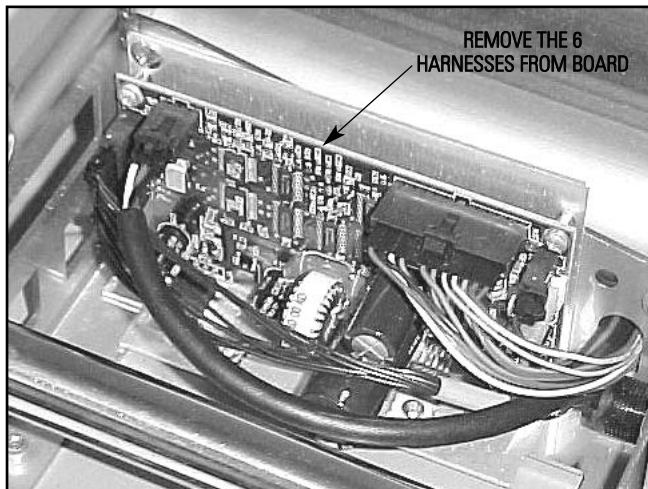

FIGURE 6.5

Using the #2 Phillips Screwdriver, remove the two mounting screws securing the Main PC Board Assembly to the unit. See Figure 6.6.

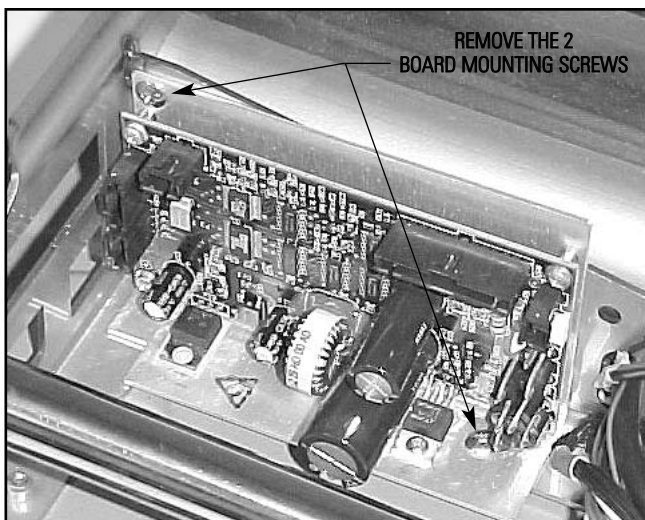

FIGURE 6.6

NOTE:

The Main PC Board is permanently mounted to the aluminum mounting bracket.

D. Replacement Component Part Numbers

Main PC Board Assembly J6043

E. Main PC Board Replacement

Replace in reverse order. When connecting harnesses, each harness will only connect to their respective locations on the board.

6.3 Motor PC Board Removal & Replacement

A. Tools Required

#2 Phillips Screwdriver

B. Motor Cover Removal

Remove Motor Cover. Refer to "6.1. Cover Removal & Replacement".

C. Motor PC Board Removal

Disconnect the three wiring harnesses from the Motor PC Board. See Figure 6.7.

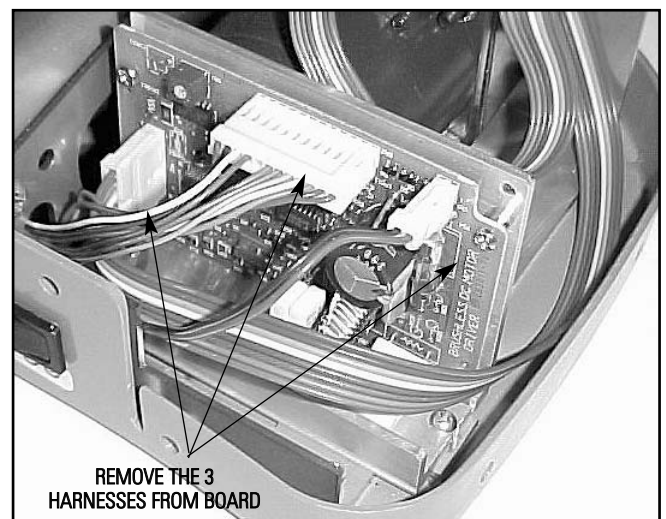

FIGURE 6.7

NOTE:

Memory for Calibration and Model Number are stored on the Main PC Board. Calibration and verification of Model Number will be necessary if the Main PC Board is replaced.

To determine Model Number, turn unit on and press the Up and Down arrows simultaneously. If "OPTIFLEX I" is displayed on pendant, it will be necessary to put unit in the Calibration Mode. See Page 16.

With unit in Calibration Mode, press the "Mode" button. The pendant display should change from "OPTIFLEX I" to "OPTIFLEX II". Unit is now ready for Calibration.

Using the #2 Phillips Screwdriver, remove the two mounting screws securing the Motor PC Board Assembly to the unit. See Figure 6.8.

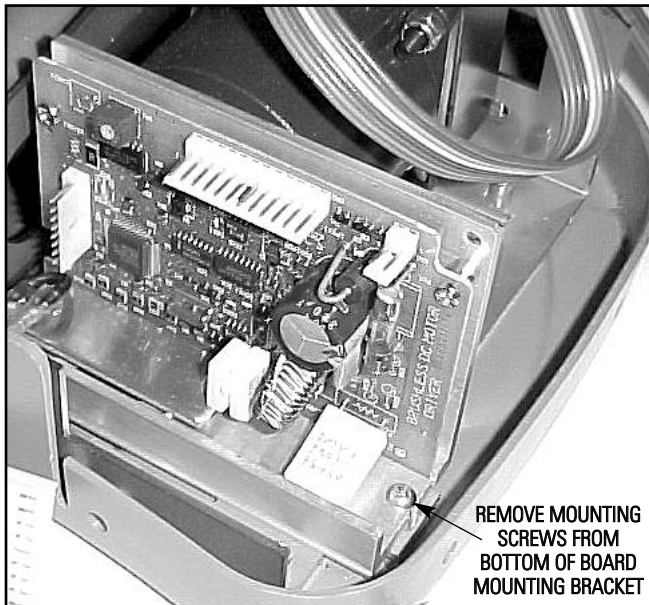

FIGURE 6.8

D. Replacement Component Part Numbers

Motor PC Board Assembly. J6010

E. Motor PC Board Replacement

Replace in reverse order. When connecting harnesses, each harness will only connect to their respective locations on the board.

⚠ WARNING

UNPLUG THE UNIT FROM THE POWER SOURCE BEFORE ATTEMPTING ANY REMOVAL OR REPLACEMENT PROCEDURES TO PREVENT ELECTRICAL SHOCK.

6.3 Drive Belt Removal & Replacement

A. Tools Required

- #2 Phillips Screwdriver
- 9/64" Allen Wrench
- Preset 10 inch-pound "T"-Handle Torque Wrench

B. Motor Cover Removal

Remove Motor Cover. Refer to "6.1. Cover Removal & Replacement".

C. Belt Removal

Loosen the three Motor Mounting Screws. See Figure 6.9.

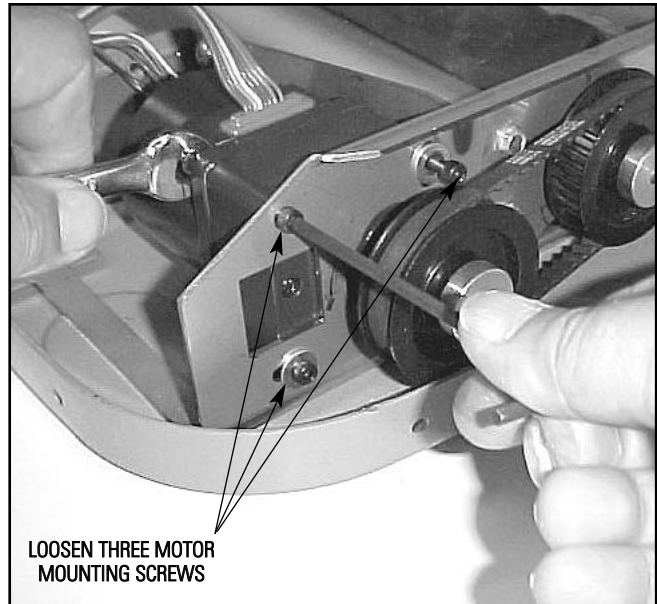

FIGURE 6.9

Rotate the motor toward the center of the unit to loosen the tension from the belt. Tighten the one Motor Mounting Screw in the upper left hand corner. Remove the old belt from the pulleys.

D. Drive Belt Replacement Part Number

Motor Drive Belt. J2000

E. Drive Belt Replacement

Replace Drive Belt in reverse order. Rotate motor by hand applying tension to the belt. Make certain the belt is seated into the pulley teeth. Torque Motor Mounting Screws using the Preset 10 inch-pound "T"-Handle Torque Wrench with 9/64" straight hex key socket.

6.4 Motor Removal & Replacement

⚠ WARNING

UNPLUG THE UNIT FROM THE POWER SOURCE BEFORE ATTEMPTING ANY REMOVAL OR REPLACEMENT PROCEDURES TO PREVENT ELECTRICAL SHOCK.

A. Tools Required

- 11/32" Open End Wrench
- #2 Phillips Screwdriver
- 5/64" Allen Wrench
- 9/64" Allen Wrench
- 3/32" Allen Wrench
- Preset 10 inch-pound "T"-Handle Torque Wrench
- Preset 5 inch-pound "T"-Handle Torque Wrench
- Type N locking compound primer
- Loctite 222 (Purple) or approved equivalent
- Molykote or approved equivalent grease

B. Motor Cover Removal

Remove Motor Cover. Refer to "6.1. Cover Removal & Replacement".

C. Motor PC Board Removal

Remove Motor PC Board. Refer to "6.3 Motor PC Board Removal & Replacement".

D. Motor Removal

Loosen three motor mounting screws. Rotate motor to release belt tension and remove belt. See Figure 6.10.

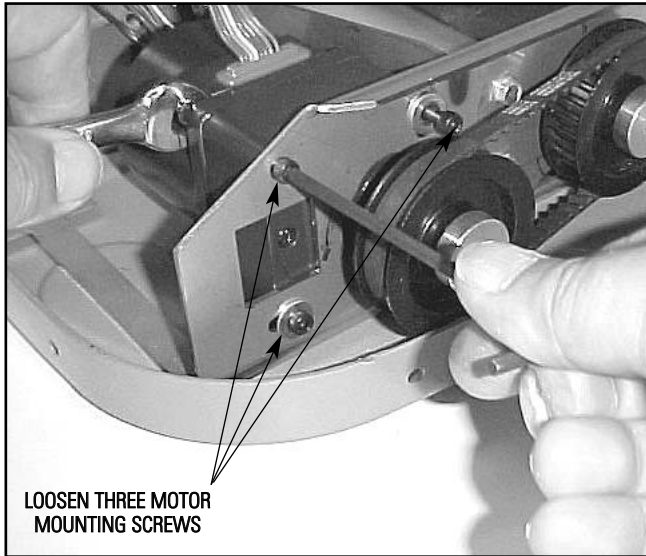

FIGURE 6.10

Using the 5/64" Allen Wrench, remove the set screw from the motor pulley. See Figure 6.11.

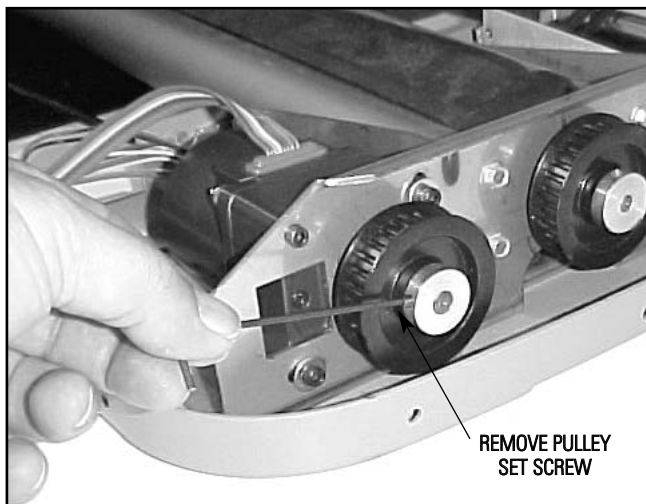

FIGURE 6.11

Remove Pulley from shaft.

NOTE:

It may be necessary to use a gear puller in removing the pulley.

Remove the three motor mounting screws using the 9/64" Allen Wrench and remove motor from unit. See Figure 6.12.

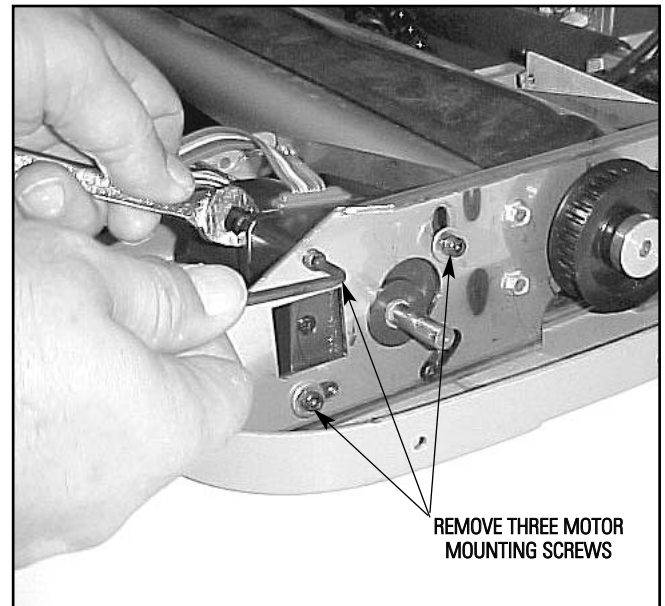

FIGURE 6.12

E. Replacement Component Part Numbers

Motor and Gearbox Assembly.40101 and 40100

F. Motor Replacement

Position the motor in the unit with ribbon cable up. Install the three Motor Mounting Screws and Nylon Lock Nuts. Do not completely tighten.

Position the pulley onto the motor shaft. Make certain the set screw hole is aligned with the flat area of the shaft.

Push the pulley onto the shaft until the face of the pulley collar is flush with the end of motor shaft.

Prime the pulley set screw with the Type N primer and apply the Loctite 222 or approved equivalent per the manufacturer's instructions to the threads of the set screw.

Install the set screw until seated against motor shaft and then torque using the Preset 5 inch-pound "T"-Handle Torque Wrench with 5/64" straight hex key socket.

Rotate motor and place belt onto both pulleys. Rotate motor in the opposite direction until belt is tight. Tighten the three motor mounting screws and torque using the Preset 10 inch-pound "T"-Handle Torque Wrench with 9/64" straight hex key socket.

Replace the Motor PC Board. Refer to "6.3 Motor PC Board Removal & Replacement".

Replace Motor Cover. Refer to "6.1. Cover Removal & Replacement".

7.1 Potentiometer (Knee Pot) Removal & Replacement

Removal and replacement of the Potentiometer (Knee Pot) can be accomplished with the following procedures.

A. Tools Required

#2 Phillips Screwdriver

Calibrated and certified Protractor with 1° accuracy or other angle measuring device that is calibrated with 1° accuracy.

Sharp tipped tool for removal of potentiometer decal
3/32" Allen Wrench

Preset 5 inch-pound "T"-Handle Torque Wrench

B. Potentiometer Decal and Cover Removal

Using a tool with a sharp tip (pocket knife) carefully remove the decal from the potentiometer cover. See Figure 7.1.

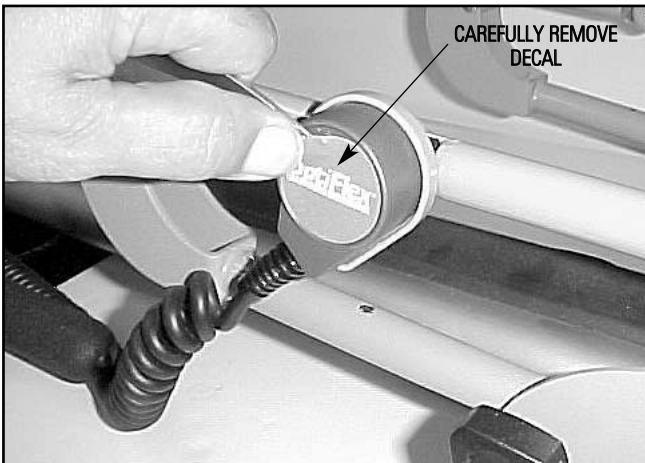

FIGURE 7.1

NOTE:

Be careful not to damage decal as it will be used for re-installation after the calibration procedure is complete.

Using the #2 Phillips Screwdriver, remove the three potentiometer cover mounting screws. See Figure 7.2.

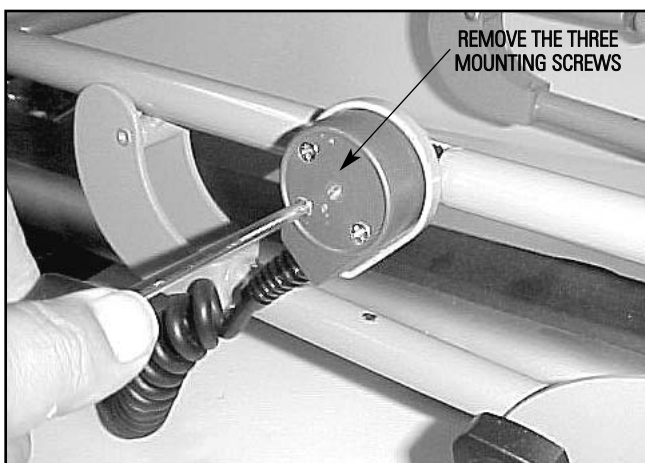

FIGURE 7.2

C. Pre-Calibration Procedure

Operate the unit until the carriage is at zero on the pendant.

Enter the "Calibration Mode" of the Pendant by pressing and holding the "Comfort Zone" button.

While holding the "Comfort Zone" button press the following buttons in the sequence listed.

1. Progressive ROM

2. Fast Back

3. O-Zone

4. Mode

5. Release the "Comfort Zone" button. "Calibration Mode OptiFlex II" should be displayed at the bottom of the Pendant display window. See Figure 7.3.



FIGURE 7.3

Place the calibrated Protractor with 1° accuracy across the carriage and press the Up and Down arrow on the Pendant until the protractor reads zero. See Figure 7.4.

FIGURE 7.4

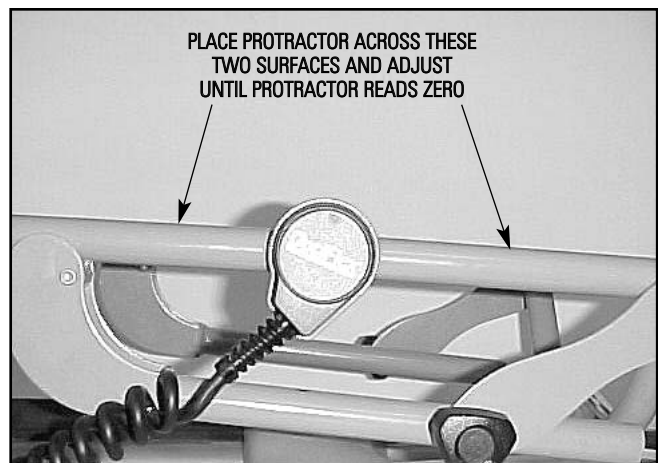

REMOVAL & REPLACEMENT

OptiFlex® 2030 & 2060

With the 3/32" Allen Wrench loosen the two set screws retaining the potentiometer in position. See Figure 7.5.

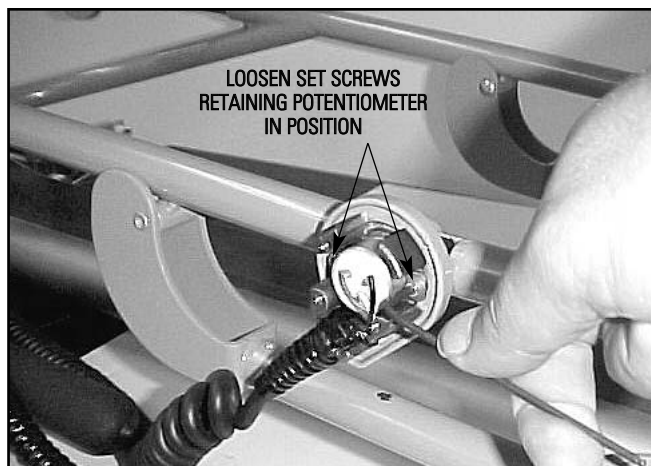

FIGURE 7.5

Rotate the potentiometer by hand until the ">0<" symbol is visible in the Pendant display. See Figure 7.6.

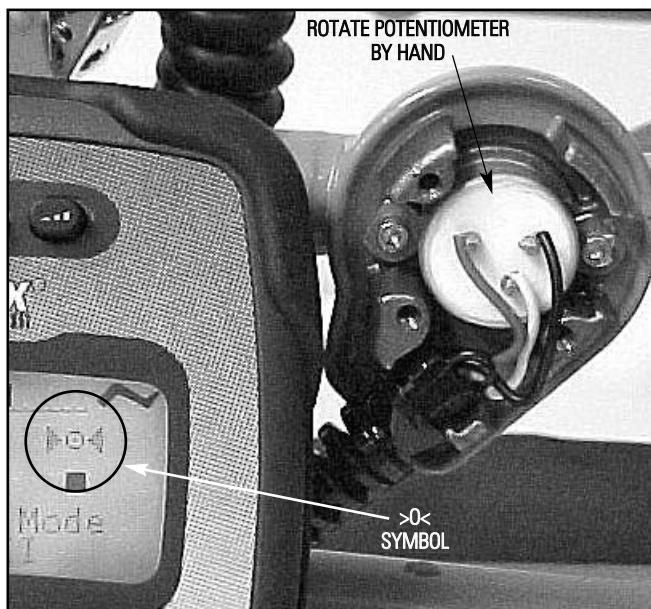



FIGURE 7.6

Tighten and torque the two set screws securing the potentiometer in position. Torque these screws using the Preset 5 inch-pound "T"-Handle Torque Wrench.

Press the Extension button. 

Press the Up arrow button until the carriage is at 90°.

Use the protractor to gage the 90° position. See Figure 7.7.

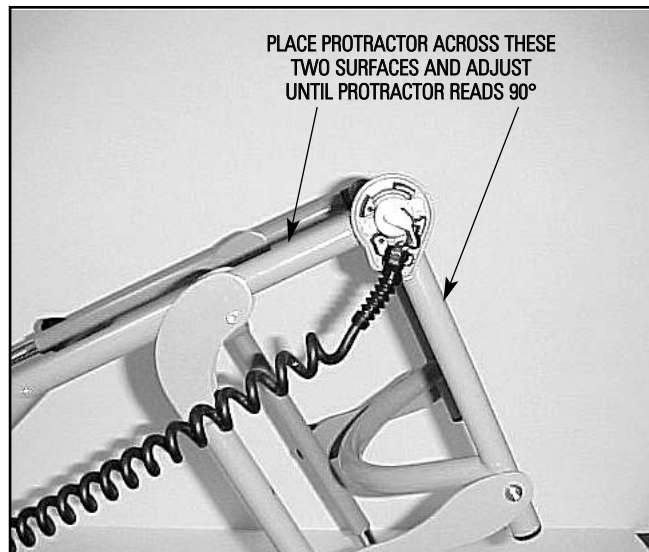

FIGURE 7.7

After verification of angle is 90° with protractor, press the Flexion button. 

Turn power to unit off.

Unit is now calibrated.

Reinstall the potentiometer cover and decal.

8.1 Annual Calibration Procedures

The OptiFlex CPM unit should be calibrated annually using the following procedures.

A. Tools Required

Calibrated and certified Protractor with 1° accuracy or other angle measuring device that is calibrated with 1° accuracy.

B. Calibration Procedure

Operate the unit until the carriage is at zero on the pendant.

Enter the "Calibration Mode" of the Pendant by pressing and holding the "Comfort Zone"  button.

While holding the "Comfort Zone" button press the following buttons in the sequence listed.





-  1. Progressive ROM
-  2. Fast Back
-  3. O-Zone
-  4. Mode
5. Release the "Comfort Zone" button. "Calibration Mode OptiFlex II" should be displayed at the bottom of the Pendant display window. See Figure 8.1.



FIGURE 8.1

Place the calibrated Protractor with 1° accuracy across the carriage and press the Up and Down arrow on the Pendant until the protractor reads zero. See Figure 8.2.

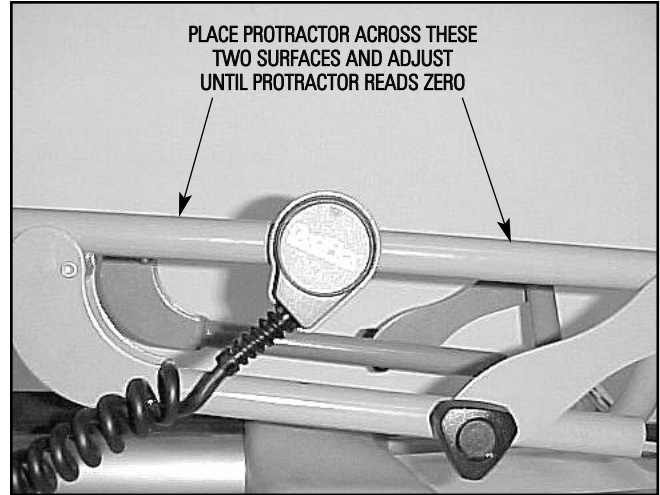



FIGURE 8.2

To set "Zero", press the Extension button.  The >0< will be replaced by two arrows pointing left. Use the arrow up button to move carriage to 90°. When Carriage reaches 90° the >0< should be visible. Verify the carriage is at 90° with the calibrated protractor or other measuring device. Once 90° is verified, press the Flexion button.  Press the Start/Stop button. Unit is now calibrated.

REPLACEMENT PARTS

OptiFlex® 2030 & 2060

With Femur Bar

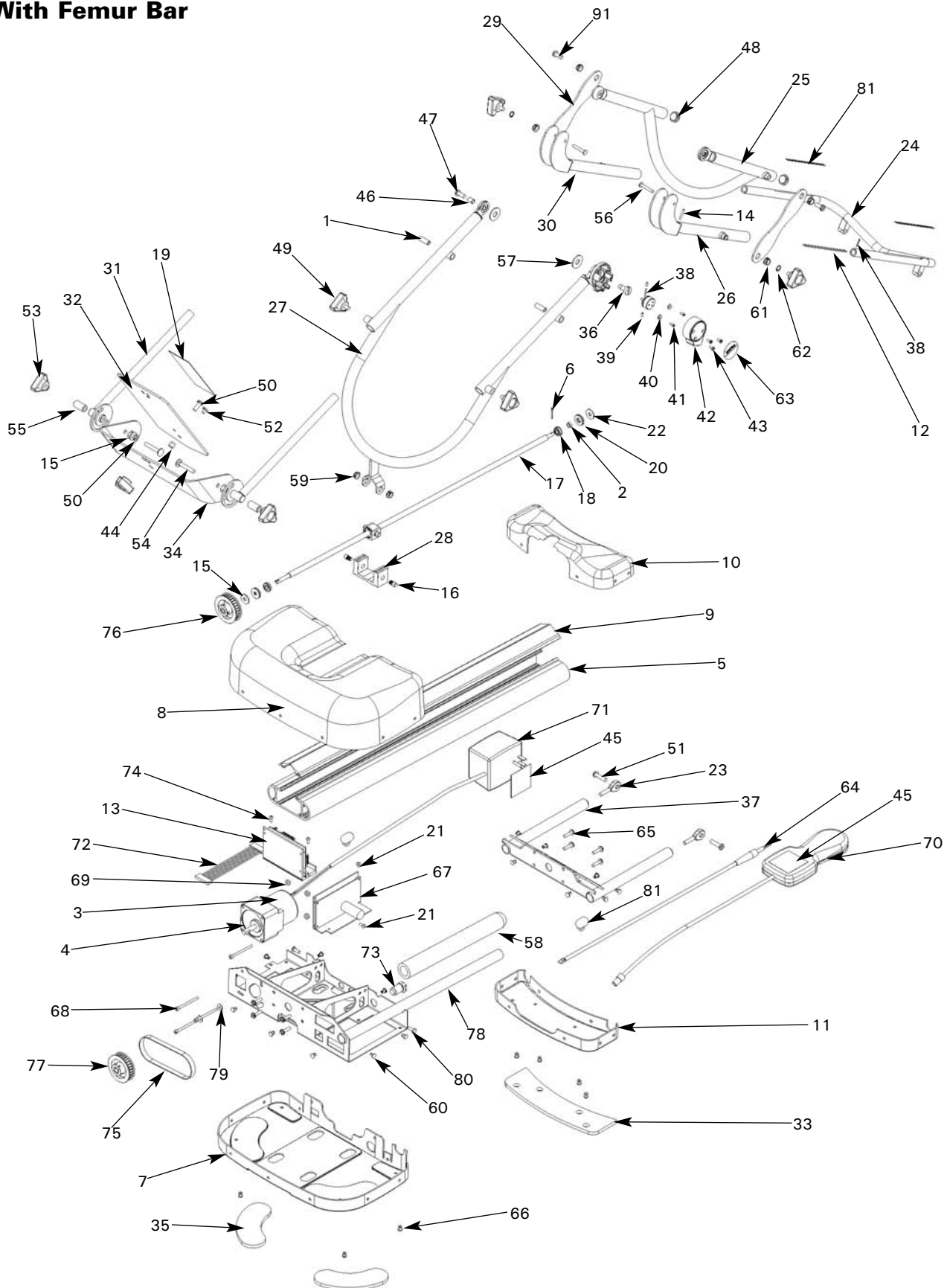

With Femur Bar

1	J6028	BUSHING, NYLON 5/16" OD	42	J1003	COVER, POT
2	J1072	BUSHING, NYLON 3/8" OD	43	J6024	SCREW, POT MOUNT, #6-32
3	40100	MOTOR, BRUSHLESS	44	J1071	PIN, FOOT ROTATION
4	40101	GEARBOX	45	J1068	VELCRO LOOP
5	J2003	EXTRUSION	46	J1061	SLEEVE, CARRIAGE PIVOT
6	J6035	PIN, COTTER	47	J6007	SCREW, PIVOT, 1/4"-28 X 5/8"
7	J2008	COVER, REAR BOTTOM	48	65991	TUBE PLUG
8	J2007	COVER, REAR TOP	49	J6012	KNOB, MALE 1/4"-20
9	J1025	WIPER	50	62066	SCREW, 1/4"-20 X 5/8"
10	J2005	COVER, FRONT TOP	51	J6052	SCREW, 1/4"-20 X 1"
11	J2006	COVER, FRONT BOTTOM	52	60396	SCREW, #10-32 X 1/4"
12	J1063	FEMUR BAR CATCH	53	J6011	KNOB, FEMALE
13	J6010	PCB MOTOR CONTROL	54	J6025	BOLT, STOVE
14	87898	SPLIT PIN, .125" X 3/4"	55	J6029	SPACER, NYLON FOOT PLATE
15	J6044	WASHER, .252 X .62 X .06 Thk	56	J6027	RIVET, FEMUR HINGE
16	J1055	PIN, TRUNION	57	J6006	WASHER, .312"ID X 1"OD X .06
17	J2004	ACME ROD	58	68964	FOAM, HANDLE GRIP
18	J6008	BEARING, FLANGE	59	J6001	BEARING, SPLIT FLANGE TRUN
19	J1067	VELCRO HOOK	60	J6004	NYLON SNAP RIVET
20	J6009	BEARING, ROLLER	61	J6005	BEARING, SPLIT FLANGE PIVOT
21	71319	SCREW, 6-32 X 1/4"	62	J6051	SNAP RING
22	J6034	WASHER, FLAT BEARING	63	J1050	DECAL, POT
23	J6020	ROD END, PLATED	64	J6040	CABLE, KNEE POT
24	J1014	FEMUR SUB ASSEMBLY	65	J6000	SCREW, SELF TAP #10-24
25	J1022	THIGH S/A	66	66058	RIVET
26	J1026	FEMUR HINGE LF	67	J6043	PCB, MAIN
27	J1011	CALF S/A	68	J6048	SCREW, 8-32 X 2" SOCKET HD
28	J1034	SLIDER	69	21733	NUT, #8-32 ESNA
29	J1032	FEMUR LINKAGE	70	J2022	PENDANT S/A
30	J1030	FEMUR HINGE RT	71	J6056	POWER SUPPLY (120V UNIT)
31	J1036	FOOT ROD S/A		J6053	POWER SUPPLY (220V UNIT)
32	J2014	FOOT PLATE	72	J6042	MOTOR CONTROLLER CABLE
33	J1058	PAD, FRONT	73	J2023	CABLE, PENDANT RECEPTICAL
34	J2013	FOOT PLATE, FORMED	74	70099	SCREW, #6-32 X 3/8"
35	J1057	PAD, REAR	75	J2000	DRIVE BELT
36	J1041	PIN, POT PIVOT	76	J2001	PULLEY, BALL SCREW
37	J1075	BASE, FRONT S/A	77	J2002	PULLEY, MOTOR
38	J6023	SPLIT PIN, 1/16" X 9/16"	78	J2009	BASE, REAR S/A
39	J6022	TUBE, POT PIN	79	70105	WASHER #10 FLAT
40	J6003	SERVO MOUNT CLEAT	80	53973	SCREW, #10 X 1/2" PAN TEK
41	J6002	SCREW, #4-40	81	J6065	RIGHT ANGLE STRAIN RELIEF

Without Femur Bar

1	J6028	BUSHING, NYLON 5/16" OD	46	J1061	SLEEVE, CARRIAGE PIVOT
2	J1072	BUSHING, NYLON 3/8" OD	47	J6007	SCREW, PIVOT, 1/4"-28 X 5/8"
3	40100	MOTOR, BRUSHLESS	48	65991	TUBE PLUG
4	40101	GEARBOX	49	J6012	KNOB, MALE 1/4"-20
5	J2003	EXTRUSION	50	62066	SCREW, 1/4"-20 X 5/8"
6	J6035	PIN, COTTER	51	J6052	SCREW, 1/4"-20 X 1"
7	J2008	COVER, REAR BOTTOM	52	60396	SCREW, #10-32 X 1/4"
8	J2007	COVER, REAR TOP	53	J6011	KNOB, FEMALE
9	J1025	WIPER	54	J6025	BOLT, STOVE
10	J2005	COVER, FRONT TOP	55	J6029	SPACER, NYLON FOOT PLATE
11	J2006	COVER, FRONT BOTTOM	56	J6027	RIVET, FEMUR HINGE
12	J1063	FEMUR BAR CATCH	57	J6006	WASHER, .312"ID X 1"OD X .06
13	J6010	PCB MOTOR CONTROL	58	68964	FOAM, HANDLE GRIP
14	87898	SPLIT PIN, .125" X 3/4"	59	J6001	BEARING, SPLIT FLANGE TRUN
15	J6044	WASHER, .252 X .62 X .06 Thk	60	J6004	NYLON SNAP RIVET
16	J1055	PIN, TRUNION	61	J6005	BEARING, SPLIT FLANGE PIVOT
17	J2004	ACME ROD	62	J6051	SNAP RING
18	J6008	BEARING, FLANGE	63	J1050	DECAL, POT
19	J1067	VELCRO HOOK	64	J6040	CABLE, KNEE POT
20	J6009	BEARING, ROLLER	65	J6000	SCREW, SELF TAP #10-24
21	71319	SCREW, 6-32 X 1/4"	66	66058	RIVET
22	J6034	WASHER, FLAT BEARING	67	J6043	PCB, MAIN
25	J1022	THIGH S/A	68	J6048	SCREW, 8-32 X 2" SOCKET HD
26	J1026	FEMUR HINGE LF	69	21733	NUT, #8-32 ESNA
27	J1011	CALF S/A	70	J2022	PENDANT S/A
28	J1034	SLIDER	71	J6056	POWER SUPPLY (120V UNIT)
29	J1032	FEMUR LINKAGE		J6053	POWER SUPPLY (220V UNIT)
30	J1030	FEMUR HINGE RT	72	J6042	MOTOR CONTROLLER CABLE
31	J1036	FOOT ROD S/A	73	J2023	CABLE, PENDANT RECEPTICAL
32	J2014	FOOT PLATE	74	70099	SCREW, #6-32 X 3/8"
33	J1058	PAD, FRONT	75	J2000	DRIVE BELT
34	J2013	FOOT PLATE, FORMED	76	J2001	PULLEY, BALL SCREW
35	J1057	PAD, REAR	77	J2002	PULLEY, MOTOR
36	J1041	PIN, POT PIVOT	78	J2009	BASE, REAR S/A
38	J6023	SPLIT PIN, 1/16" X 9/16"	79	70105	WASHER #10 FLAT
39	J6022	TUBE, POT PIN	80	53973	SCREW, #10 X 1/2" PAN TEK
40	J6003	SERVO MOUNT CLEAT	81	J6065	RIGHT ANGLE STRAIN RELIEF
41	J6002	SCREW, #4-40	82	J1089	CLEVIS PIN 1/4" X 1" X 3/8" SS
42	J1003	COVER, POT	83	J1084	WELDMENT, TUBE
43	J6024	SCREW, POT MOUNT, #6-32	84	J1085	WELDMENT, BASE FRAME
44	J1071	PIN, FOOT ROTATION	85	54931	PIN, SPLIT 3/32" X 5/8" PLT
45	J1068	VELCRO LOOP			



ISO 9001/ISO 13485 CERTIFIED

4717 Adams Road
P.O. Box 489
Hixson, TN 37343 U.S.A.
1-423-870-2281
1-800-592-7329 U.S.A.
1-800-361-6661 CANADA
+ 1-423-870-2046 OUTSIDE U.S.A. FAX
www.chattgroup.com

Part Number: 20696A

© 2002 Encore Medical